

FLUIDRA

Catalogue
WELLNESS

FLUIDRA

C A T A L O G U E

Wellness



www.astralpool.com

“And just when the caterpillar thought the end had come, it transformed into a butterfly...”



Welcome to your Renaissance moment...



We grow up rushing to reach tomorrow. We carve out time from our daily lives to build a future, without appreciating the meaning of the journey, without appreciating that life is the path.

The only path is one of constant search, daily resurrection, rebirth without fear.

The 4 doors

I wake up, I cross the threshold, I am instantly overcome by a sense of peace. I don't know how to explain it. I close my eyes and I notice a soft perfume wafting on the air that transports me, I feel like my feet aren't touching the ground, a sense of being almost weightless...

I don't recognize the place. I only see four doors before me, a word written on each. I'm filled with a deep sense of curiosity. What could be behind each one?





I look closely at the first door, where I can make out the word **Phoenix** in golden letters. I clearly remember the legend about the mythical bird of Greek mythology that was consumed by fire every 500 years, but then rose from its own ashes.

I keep walking and approach the second door; where I can read the words **Al-Haya**. The elixir of life, coveted and sought after since time immemorial and, it is said, the source of eternal youth, a legendary potion that grants the drinker eternal life.



The third door also surprises me with its gorgeous golden letters spelling the word **Chrysalis**. The most important stage in the metamorphosis of the caterpillar, which weaves a delicate silk cocoon after reaching full growth and turns into a beautiful butterfly.

I have one door left, and on it is written **Daphne**, a forest nymph from Greek mythology, transformed into a laurel tree and a symbol of victory.

It seems like I'm in a magical place, each door holding a promise. Time has come to a standstill and the only thing I can feel is my breathing and the wish to cross those doors and enter each of those rooms.

I feel that the path to my wellbeing has just begun...





FLUIDRA

Time, quality time, is one of the most precious resources in today's world, which is why Fluidra takes care of every detail to ensure that the wellness experience is an unforgettable one.

Once-in-a-life-time moments in unique spaces.

ASTRALPOOL 

Unlimited creation

I N N O V A T I O N

We innovate new worlds, design new dreams, and explore unknown paths...

We provide our clients with creative and sustainable solutions that respect the details and quality that goes hand in hand with craftsmanship.

To be born, to grow, and to keep growing.



HOTEL MONASTERO DI CORTONA - ITALY



HOTEL ESENCIA - MÉXICO



HAVEN RIVIERA CANCÚN - MÉXICO

We're global

WITH YOU

Our multiculturalism and global perspective connect us to our clients.

Together, we work to create flawless experiences anywhere in the world.



Our success
is your success.

We're backed by our experience.
Over 6,000 projects completed over the past 50 years.

E X P E R I E N C E

Projects

FLUIDRA

Experts in wellness solutions and equipment.

Our integrated business model makes it possible to offer turnkey solutions as a one-stop wellness partner from start to finish: from the project's design phase to on-site implementation.

We also offer flexible, outstanding service at every step, springing into action only to cover our clients' needs.



Planning and conceptual design

The conceptual design is developed during the planning phase, making it possible to visualize the essence of the project as it is being designed, combining the requirements of the client's business plan with inspiring conceptual ideas.

In this phase, the working plan for each area of the wellness space is defined, as well as the best way for users to move around.

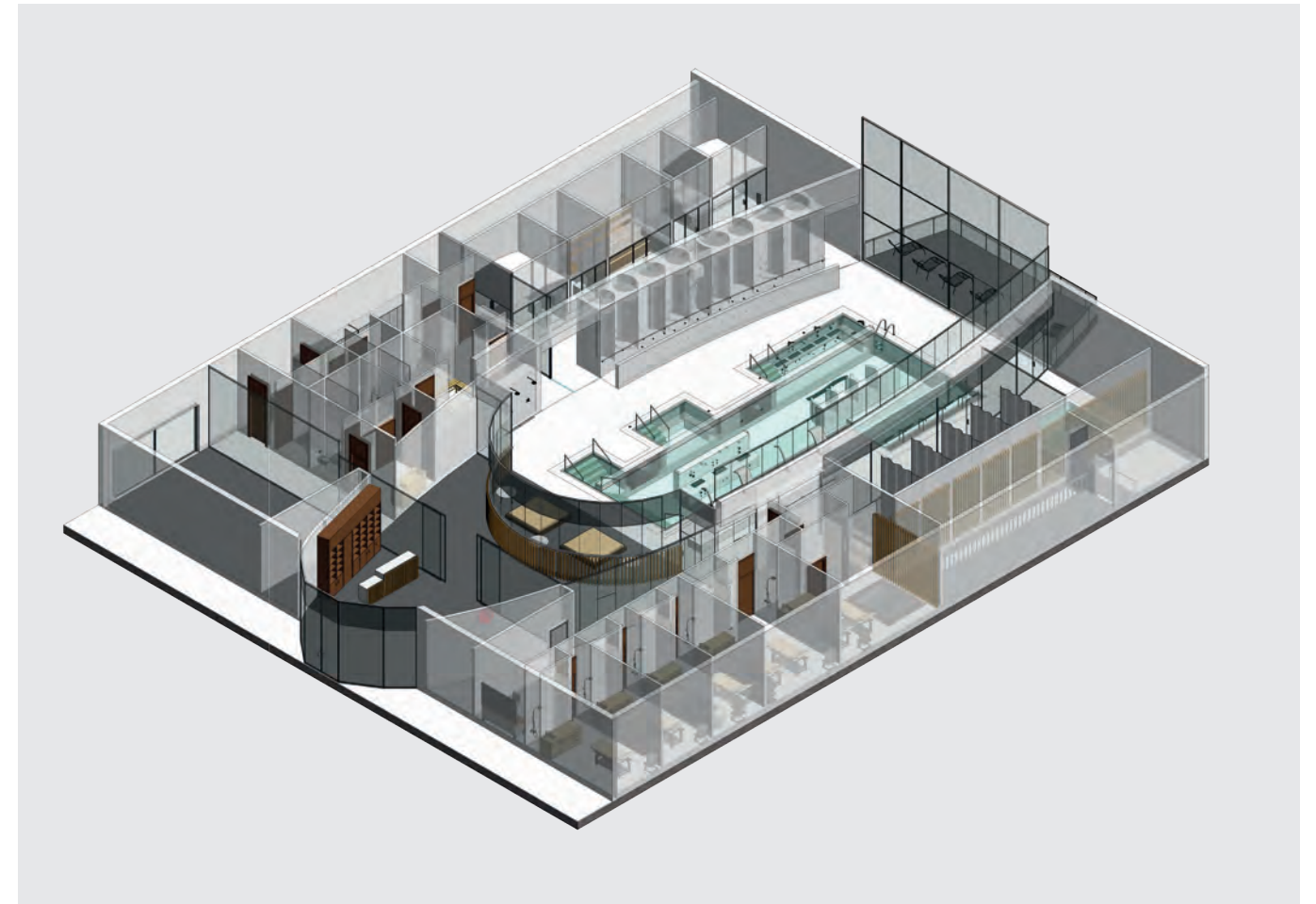

Design development

Once the conceptual phase is complete, our team develops the architectural, installation, and wellness equipment designs, proposing innovative solutions for a unique and functional project.

Product manufacturing and distribution.

In this phase, we put our own production centers to work to manufacture all the equipment required for the project, turning the designs from the previous phase into a reality under the strictest quality standards.



Installation and project management.

Getting the equipment installation process right is crucial for an excellent result. Which is why we offer installation and supervision at every step of the project, from assembly to launch.

The four doors

CONTENT

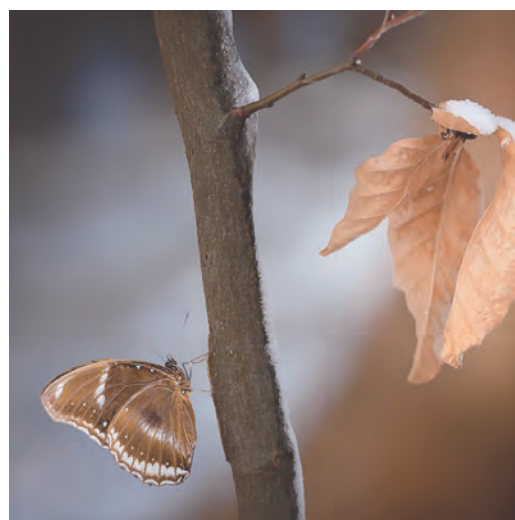
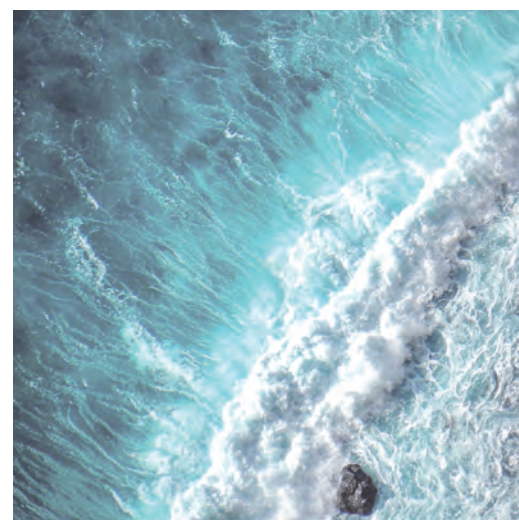
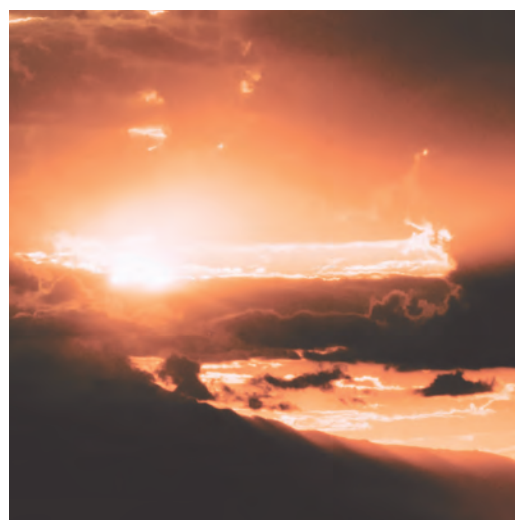

01 Phoenix TEMPERATURE

- Sauna
- Steam Bath
- Ice Cabin
- Ice Fountain
- Ceramic
- Snow Machine

02 Al-Haya WATER

- Showers
- Mini contrast pool
- Vitality Pool
- Hydro Leisure Elements
- Spas
- Nordic bath

03 Chrysalis RELAX

- Loungers

04 Daphne TREATMENTS

- Treatment showers
- Halotherapy systems
- Portable massage bed
- Spa Tables
- Moodify

+ Product specifications



Phoenix

T E M P E R A T U R E Z O N E

The sun recreated its reflection in the bird's glorious feathers, gold and red enveloped the sunset, and there was no world beyond the burning fire where the bird would find its end.

The fiery ashes held the seed, the rebirth of life, indestructible, immortal, a life that found a way despite the most brutal of fates.

She cared for her only egg in a nest lovingly built with aromatic herbs and spices and, burned completely on the third day, the Phoenix arises from her ashes, splendid, invincible.

The resurrection of life, spirit, body, and mind united in an eternal song.

- 1.1.1. Classic
- 1.1.2. Borro
- 1.1.3. Miramonte
- 1.1.4. Fiora
- 1.1.5. Nera
- 1.1.6. St. Moritz
- 1.1.7. Innsbruck
- 1.1.8. Lobos
- 1.1.9. Bella
- 1.1.10. Honey
- 1.1.11. Essentia
- 1.1.12. Outdoor



TEMPERATURE ZONE

1.1

Sauna

Source of health and well-being.

In addition to their spiritual side, saunas have been used for medicinal purposes for thousands of years.

Our ancestors sensed their therapeutic benefits and modern science confirms them.

A sauna is an excellent way to improve the blood and motor system, reduce muscle pain, and increase joint movement. It is also a good partner for our skin, leaving it bright and beautiful.

A sauna is the answer. Having a sauna boosts vitality and energy, helping us stay healthy.

More saunas, more health and well being.

CLIMATE CONTROL TABLE

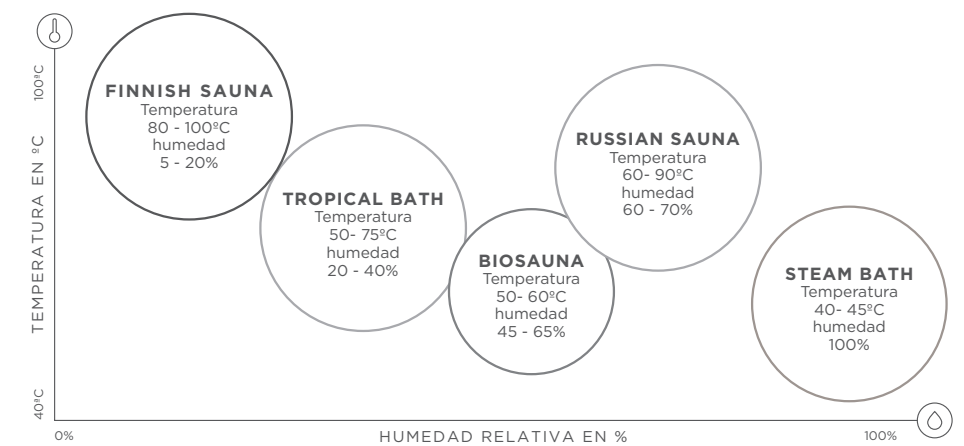



Bespoke Sauna

WOOD CRAFTSMEN .

We custom build the Sauna for your project taking care of every detail and providing all our knowledge.





Essentia

SAUNA

The Essentia sauna is a study in precise lines, creativity, and extreme attention paid to every detail. It blends the Nordic tradition with the elegance of a contemporary design in more than balanced proportions that make it an excellent choice for current wellness spaces.

Dimensions (cm): 200 x 200 x 225
250 x 200 x 225
250 x 250 x 225
300 x 250 x 225

— Details: p. 318



Bella

SAUNA

Complete design with elegant lines
specially designed for public use facilities.

Dimensions (cm): 180 x 180 x 210
230 x 180 x 210
230 x 230 x 210
280 x 230 x 210

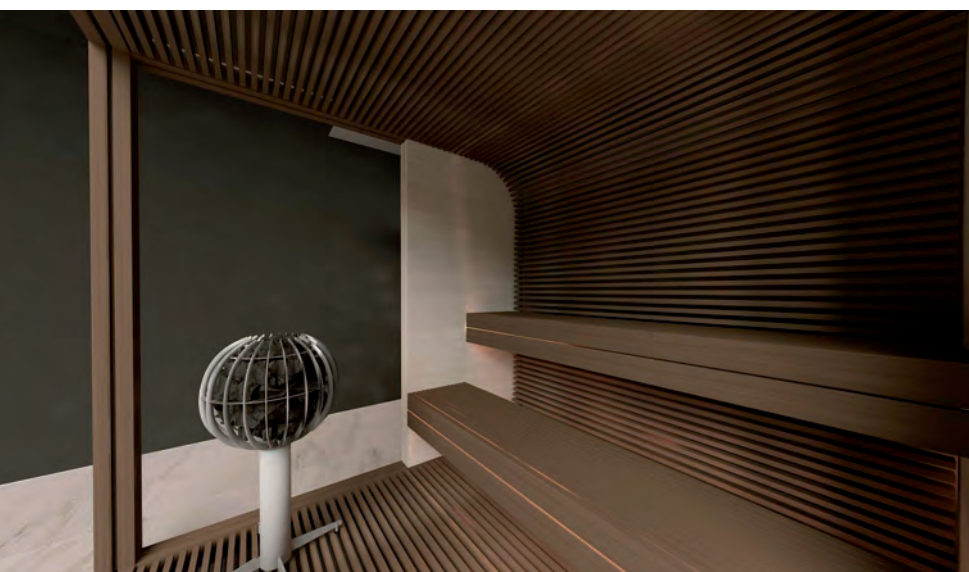

— Details: p. 318

Lobos

SAUNA

Clear design
Premium wood quality
Elegant details

Dimensions (cm): 134 x 254 x 210
194 x 194 x 210
254 x 254 x 210



— Details: p. 317

Honey

SAUNA

With an innovative design based on bee hives, the Honey sauna meets demands for both residential and public use.

Dimensions (cm): 180 x 180 x 212
233 x 180 x 212
233 x 233 x 212
285 x 233 x 212
285 x 285 x 212

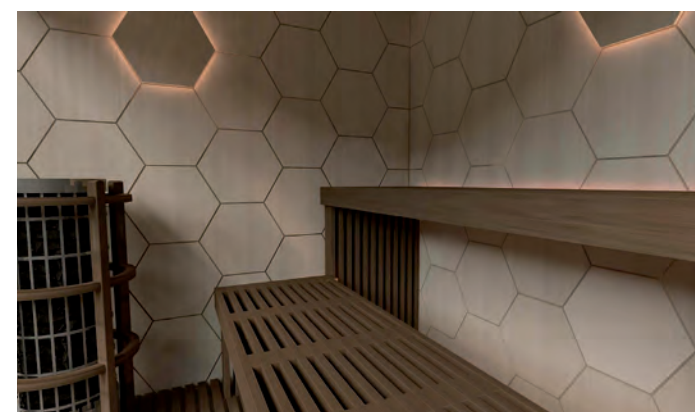

— Details: p. 318



Innsbruck

SAUNA

Complete design of elegant lines specially designed for public use facilities.

Dimensions (cm): 135 x 135 x 210
180 x 180 x 210
220 x 220 x 210
260 x 220 x 210
300 x 250 x 210
300 x 300 x 210

———— Details: p. 317

St. Moritz

S A U N A

Elegant and exclusive design sauna. With premium quality wood for residential and public use facilities.

Dimensions (cm):

- 135x135x210
- 180x180x210
- 220x220x210
- 260x220x210
- 300x250x210
- 300x300x210

Details: p. 317



Borro

S A U N A

Elegant, refined sauna.
Premium wood and carefully designed details.
Perfect for both public and private use.

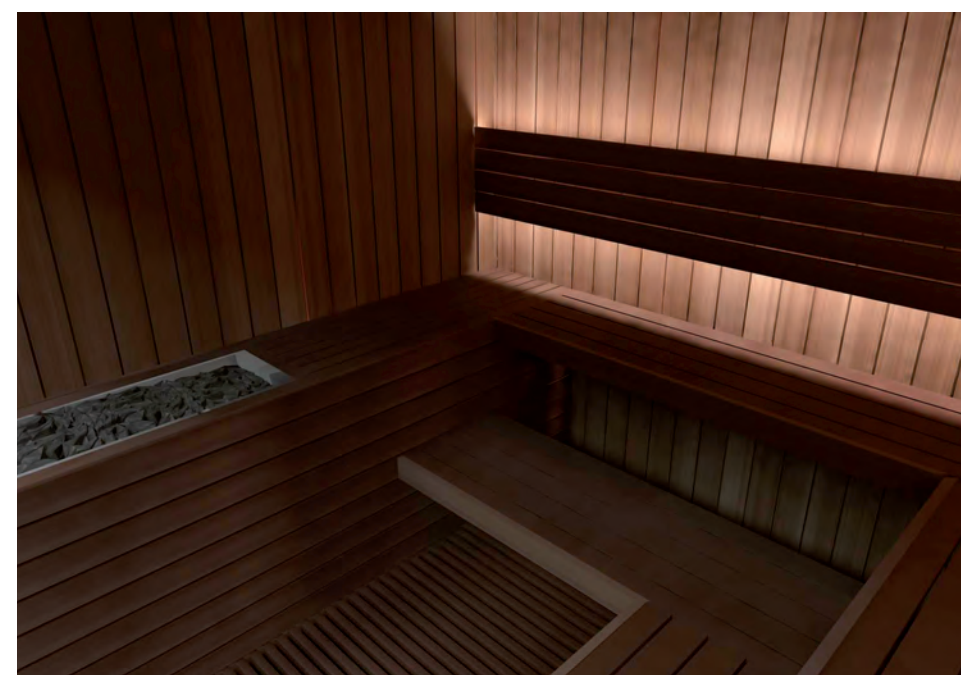

- Dimensions (cm):** 200 x 200 x 210
250 x 220 x 210
250 x 250 x 210
300 x 250 x 210
300 x 300 x 210
400 x 300 x 210

— Details: p. 316



Nera

SAUNA

Disruptive and innovative. The new Nera sauna is made of horizontal spruce panels painted in black. Cantilevered benches in light tones balance perfectly with the dark walls.

Dimensions (cm):

180 x 180 x 210
 200 x 200 x 210
 250 x 200 x 210
 250 x 250 x 210

Details: p. 317





Fiora

SAUNA

Fiora, AstralPool's new sauna, represents the evolution of classic Finnish design. Made with horizontal spruce panels and open benches, it blends classic sauna culture with the most sophisticated design.

Dimensions (cm): 180 x 180 x 210
 200 x 200 x 210
 250 x 200 x 210
 250 x 250 x 210

— Details: p. 316

Miramonte

SAUNA

Astralpool's new generation sauna model with elegant and exclusive design. Made with high quality and durable wood for public use facilities.



Dimensions (cm): 200 x 150 x 210
 200 x 200 x 210
 250 x 200 x 210
 250 x 250 x 210
 300 x 250 x 210
 300 x 300 x 210

— Details: p. 316



Classic

SAUNA

Classic Finnish design combined with cutting-edge technology. AstralPool's Classic sauna is crafted in vertical spruce panels in the Finnish tradition. It can be made in other types of wood on request.

Dimensions (cm): 150 x 150 x 210
 200 x 150 x 210
 200 x 200 x 210
 250 x 200 x 210
 250 x 250 x 210
 300 x 250 x 210
 300 x 300 x 210
 400 x 300 x 210

— Details: p. 316



Outdoor

S A U N A

Install any outdoor sauna with AstralPool's new Outdoor Hut. Made to measure, it protects the most delicate materials from the most severe climatic conditions.

Dimensions (cm): tailor-made on request

— Details: p. 318

1.2.1. Asana
1.2.2. Bandha

1.2.3. Cala
1.2.4. Hara

1.2.5. Sutra
1.2.6. Configurable & Bespoke

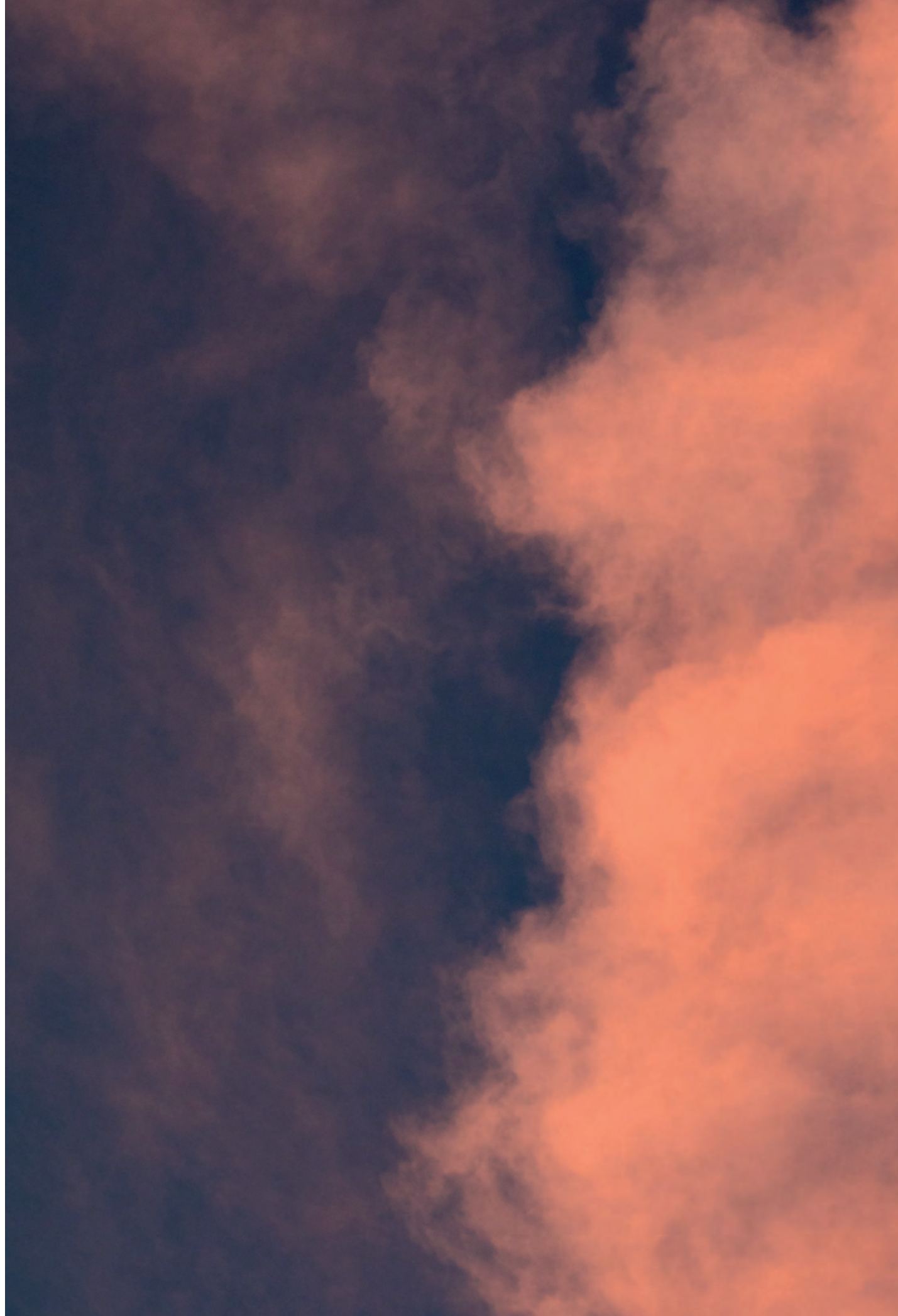

T E M P E R A T U R E Z O N E

1.2

Steam Baths

Straight lines, refined and elegant design. AstralPool's steam rooms offer exclusive designs adapted to the most advanced technology on the market.

The use of prefabricated modules remove on-site construction issues and speeds up construction times. Capable of withstanding the extreme humidity and temperature produced by the steam generator.

AstralPool's steam rooms are a complete solution that includes all the elements of a wet sauna (structure, framing, lighting, glazing, steam unit, finishes, etc.), manufactured according to our standard models or tailored to the needs of each project.



Asana

STEAM BATHS

The perfect balance between two worlds. Its straight lines and elegant finishes, fully in step with contemporary interior design trends, make Asana the ideal steam room solution for the most discerning projects, where luxury meets simplicity.

Dimensions (cm): 200 x 200 x 220
 250 x 200 x 220
 250 x 250 x 220
 300 x 250 x 220
 300 x 300 x 220

Color palette



— Details: p. 320

Bandha

STEAM BATHS

Light, peace, and warmth. Bandha's austere design encourages the already strange art of not thinking. Its warm stone and minimalist design fits perfectly in projects with pure and natural designs.

Color palette

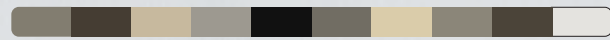

- Dimensions (cm):** 250 x 200 x 220
 250 x 250 x 220
 300 x 250 x 220
 300 x 300 x 220

— Details: p. 321

Cala

STEAM BATHS

A space created for disconnection within the urban chaos. Cala features a metropolitan and avant-garde design, a product created to be a perfect fit for wellness centers and urban spas.

Dimensions (cm): 250 x 200 x 220
250 x 250 x 220
300 x 250 x 220
300 x 300 x 220

Color palette



— Details: p. 320





Hara

STEAM BATHS

Luxury in a simple, modern, and elegant design. Following AstralPool's proposal, Hara offers a design based on straight lines and exceptional finishes with matte black frames. The contrast of colors and the combination of materials used make Hara a flawless choice for matching any style.

Dimensions (cm): 250 x 250 x 220
 300 x 250 x 220
 300 x 300 x 220

Color palette



— Details: p. 321

Sutra

STEAM BATHS

Less is more. The quintessential phrase that shaped minimalist architecture, fully reflected in the Sutra design.

Dimensions (cm):

- 250 x 200 x 220
- 250 x 250 x 220
- 300 x 250 x 220
- 300 x 300 x 220

Color palette



Details: p. 320



Configurable

STEAM BATHS

Create a custom steam room.

AstralPool's customizable option offers an infinite number of combinations: choose the ceiling finish, lighting, framing, benches, walls, as well as the interior layout and multiple accessories.

Dimensions (cm): 200 x 200 x 220

250 x 200 x 220

250 x 250 x 220

300 x 250 x 220

300 x 300 x 220

Bespoke

STEAM BATHS

At Fluidra we are aware that each project is unique and each place an experience. For this reason, we want to make it easy for you, manufacturing your ideal steam bath according to the needs of your project. A complete customized solution for the most demanding projects.

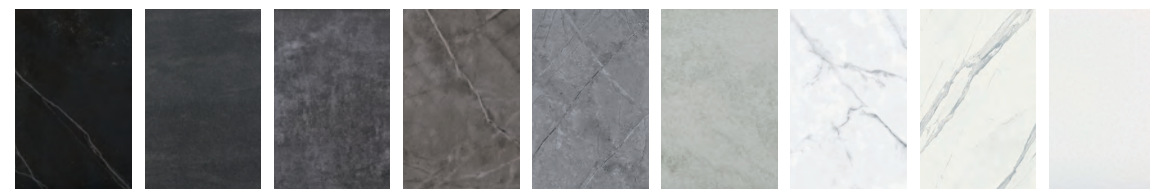

— Details: p. 322



Steam room control panel



Electronic control panel with multi-language navigation for domestic and professional steam rooms.

1.3.1. Asana
1.3.2. Bandha

1.3.3. Cala
1.3.4. Hara

1.3.5. Sutra
1.3.6. Configurable & Bespoke



T E M P E R A T U R E Z O N E

1.3

Ice Cabin

Create unique and harmonious spaces with the ice range.

Capable of withstanding extreme humidity and temperature, Astralpool's ice rooms feature compact ice spraying equipment that can generate, through a programmed dosing system and combined with cold production, an entire wall of compact ice between 5 and 10 cm thick.

Its prefabricated module construction eliminates installation errors, offering a complete solution that includes all the elements you need (structure, framing, lighting, glazing, steam unit, finishes, etc.).

Choose the standard model that best fits your project or work with us to create your perfect custom cabin.

Asana

ICE CABIN

The perfect balance between two worlds. Its straight lines and elegant finishes, fully in step with contemporary interior design trends, make Asana the ideal ice cabin solution for the most discerning projects, where luxury meets simplicity.

Dimensions (cm):

- 250 x 200 x 220
- 250 x 250 x 220
- 300 x 250 x 220
- 300x x 300 x 220

Color palette



Details: p. 324





Bandha

ICE CABIN

Light, peace, and warmth. Bandha's austere design encourages the already strange art of not thinking. Its warm stone and minimalist design fits perfectly in projects with pure and natural designs.

- Dimensions (cm):** 250 x 200 x 220
 250 x 200 x 220
 250 x 250 x 220
 300 x 250 x 220
 300 x 300 x 220

Color palette



— Details: p. 325

Cala

ICE CABIN

A space created for disconnection within the urban chaos. Cala features a metropolitan and avant-garde design, a product created to be a perfect fit for wellness centers and urban spas.



Dimensions (cm): 200 x 200 x 220
250 x 200 x 220
250 x 250 x 220
300 x 250 x 220
300 x 300 x 220

Color palette



— Details: p. 324





Hara

ICE CABIN

Luxury in a simple, modern, and elegant design. Following AstralPool's proposal, Hara offers a design based on straight lines and exceptional finishes with matte black frames. The contrast of colors and the way the materials are used make Hara a flawless choice for matching any style.



Dimensions (cm): 250 x 200 x 220
 250 x 250 x 220
 300 x 250 x 220
 300 x 300 x 220

Color palette



— Details: p. 325

Sutra

ICE CABIN

Less is more. The quintessential phrase that shaped minimalist architecture, fully reflected in the Sutra design.

Dimensions (cm):

- 250 x 200 x 220
- 250 x 250 x 220
- 300 x 250 x 220
- 300 x 300 x 220

Color palette



Details: p. 320

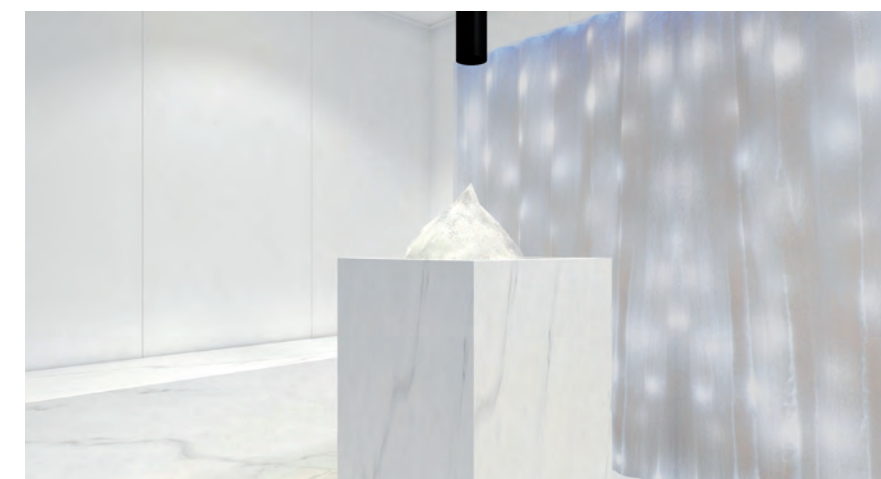

Configurable

ICE CABIN

Create a custom ice cabin.

AstralPool's customizable option offers an infinite number of combinations: choose the ceiling finish, lighting, framing, benches, walls, as well as the interior layout and multiple accessories.

Dimensions (cm): 200 x 200 x 220

250 x 200 x 220

250 x 250 x 220

300 x 250 x 220

300 x 300 x 220

Bespoke

ICE CABIN

At Fluidra we are aware that each project is unique and each place an experience. For this reason, we want to make it easy for you, manufacturing your ideal ice cabin according to the needs of your project. A complete customized solution for the most demanding projects.

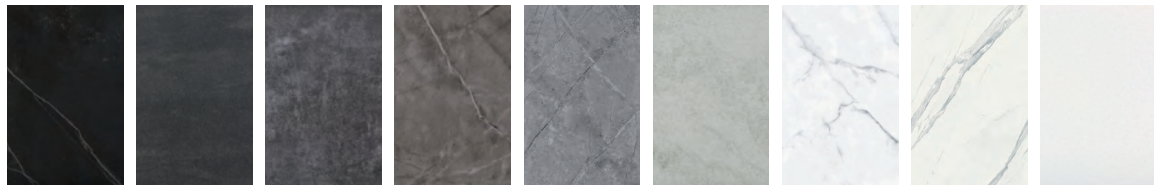

— Details: p. 326





T E M P E R A T U R E Z O N E

1.4

Ice Fountain

An ice fountain plays a starring role in any wellness space. Completes the temperature contrast cycle by stimulating the blood vessels for full mind-and-body relaxation.

AstralPool's ice fountains have two separate elements (ice maker + container) which together deliver a versatile solution that can be adapted to any type of project and design.



Ceiling dispenser (container not included)

Ice maker kit

ICE FOUNTAIN

AstralPool's ice maker kit is a robust and efficient piece of equipment that includes everything you need to quickly install and run the equipment, from the ice crusher to the stainless steel dispenser.

Available in two versions: Installation with ceiling dispenser and installation with wall dispenser.



Wall dispenser (container not included)

Ice container

WALL / CEILING

Asana



Cala



Sutra



Bandha



Hara



Configurable

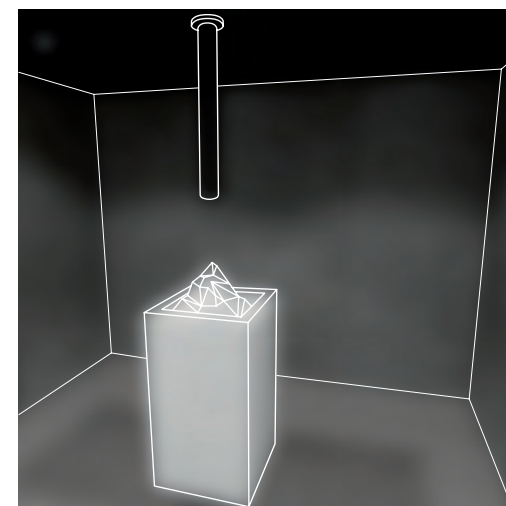
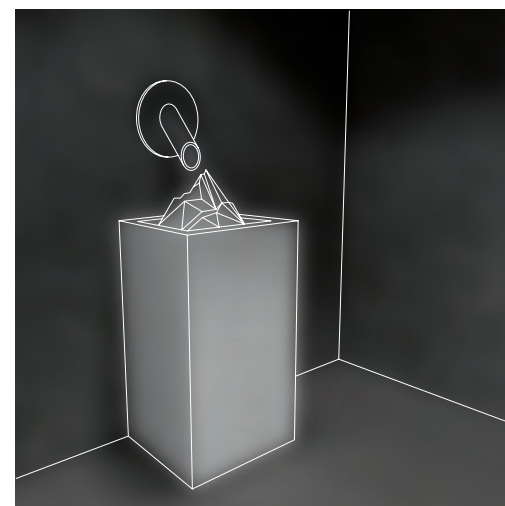

Details: p. 328

TEMPERATURE ZONE

1.5

Ceramics

Light, design, elegance, style...Discover our ceramic ranges, the balance between luxury and simplicity. Create harmonious spaces by adding a distinguished finish to your ice room, steam room, ice fountain, and loungers.



SIXTIES

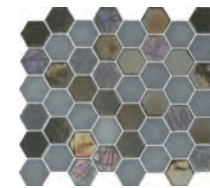

SIXTIES MATT

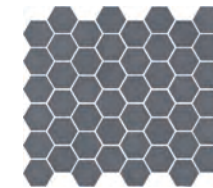

IRON 5X5

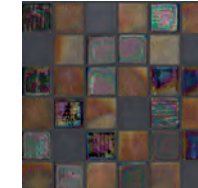

MIX DECOR

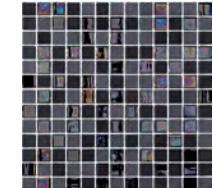

SILK / SILK

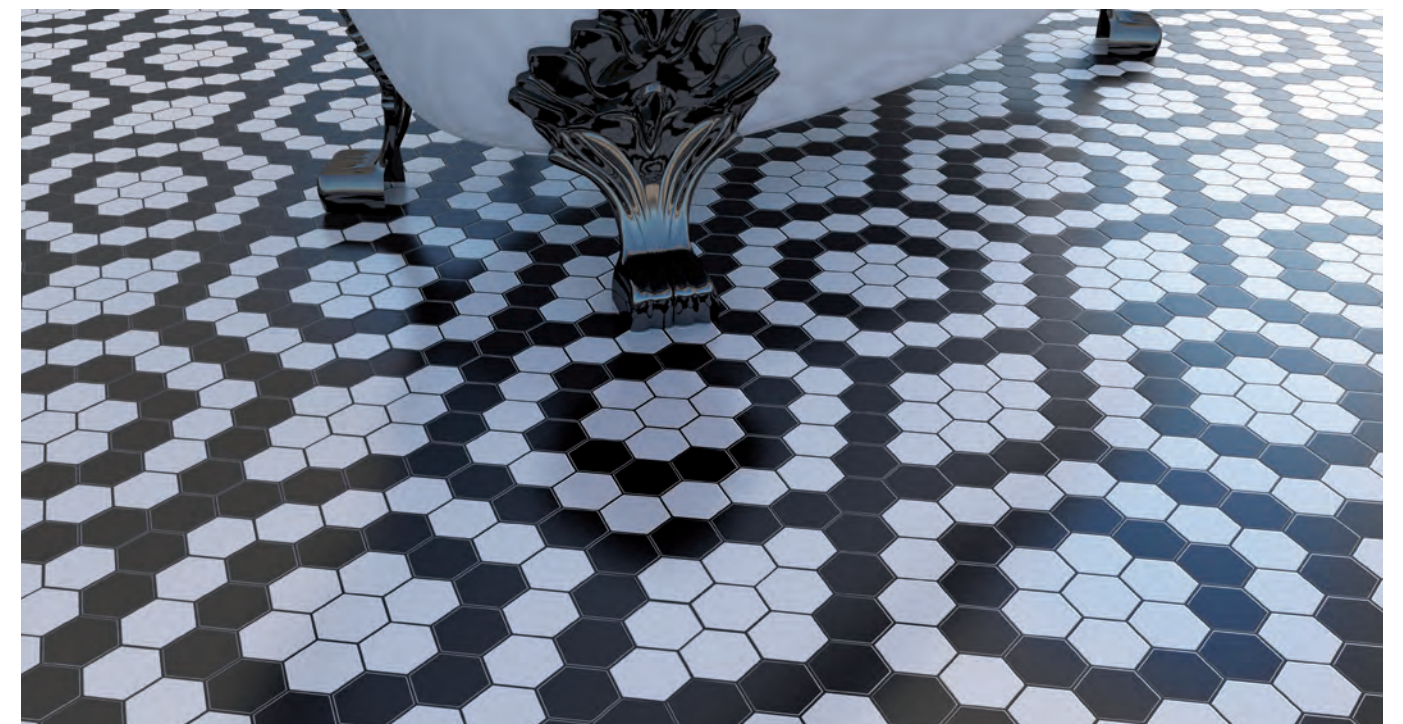
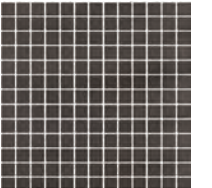



T E M P E R A T U R E Z O N E

1.6

Snow Machine

Feel the winter caressing your skin with Snowpro. Produces the finest quality natural snow and features advanced technology for use in ambient temperatures up to 45°C. Combine Snowpro with a custom-made room for your project.



SnowPro

S N O W M A C H I N E



White, cold, and refreshing snow captured on the skin. A sensation that makes you feel fragile yet free, released from the need to test your boundaries. Reinforce your inner peace and let relaxation take over.



A subtle contrast between temperature and texture that transports you to a different world, a comfortable yet motivating place.



Al-Haya

W A T E R Z O N E

Taking the intense, hard journey wasn't enough; one had to persist. The dream of the elixir of life could almost be reached, that miraculous water that, just by touching my skin, would endow my soul with an unstoppable force, that renewed energy that would give my journey a whole new meaning.

Nature had spoken, a period of silence was imposed, a pause, a forced rest for the soul. There was neither yesterday nor tomorrow, only the immense power of an expectant present, a longing that drove me to take the helm of my own existence. To take the reins of my life, our life, with humility and courage. A song of silence was raised to honor the forces of destiny.

There was no other path. Life could only be savored sip by sip, the elixir was there, within my reach, a tangible promise that the best was yet to come.



2.1.0. Accessories
2.1.1. Emotional showers
2.1.2. Emotional tunnels
2.1.3. Contrast showers
2.1.4. Horizontal shower
2.1.5. Kneipp
2.1.6. Taylor made showers



W A T E R Z O N E

2.1

Showers

From an explosive flow or as a delicate mist, water surrounds us in all its forms, a powerful and vital natural element. AstralPool's showers aim to re-create, through the contact of water with the skin, the sensation of a journey through nature at its wildest. Our showers recreate the sensory stimulation found in nature, guaranteeing a bright and beneficial fresh experience for the senses with infinite combinations of jets and lights to enhance enjoyment through the sleek and modern design of a set of shower heads created with people in mind.

Don't miss a thing. Learn everything you need to know about our jets.



RAIN

Delicate on the skin, the rain jet tickles it causing a pleasant, stimulating and relaxing sensation.



NEBULIZED

The nebulized jet slips in the environment, wrapping the body in a cosy and regenerating cloud of water.



TROPICAL

A constant and powerful jet, with an embracing and revitalizing effect, massaging the body and recharging its energy.



WATERFALL

The powerful gesture of the waterfall absorbs us and communicates its energizing force to the whole body.



AERATED

Water and air mix and enhance each other, massaging the body and inducing creativity and dynamism.



ATOMIZED

By reducing the water into tiny particles, the atomized jet gives a refreshing and relaxing feeling of wellbeing.



TROPICAL AERATED

The mix between tropical and aerated jets creates the effect of a dense rain which, descending, relieves and reduces muscular tension.



LED + NEBULIZED

A mixture of different therapies and effects, the LED light optimizes and enriches the regenerating effects of nebulization.



LED + ATOMIZED

The fusion of water particles and LED light heat enhances and intensifies the delicate touch of the atomized jet.

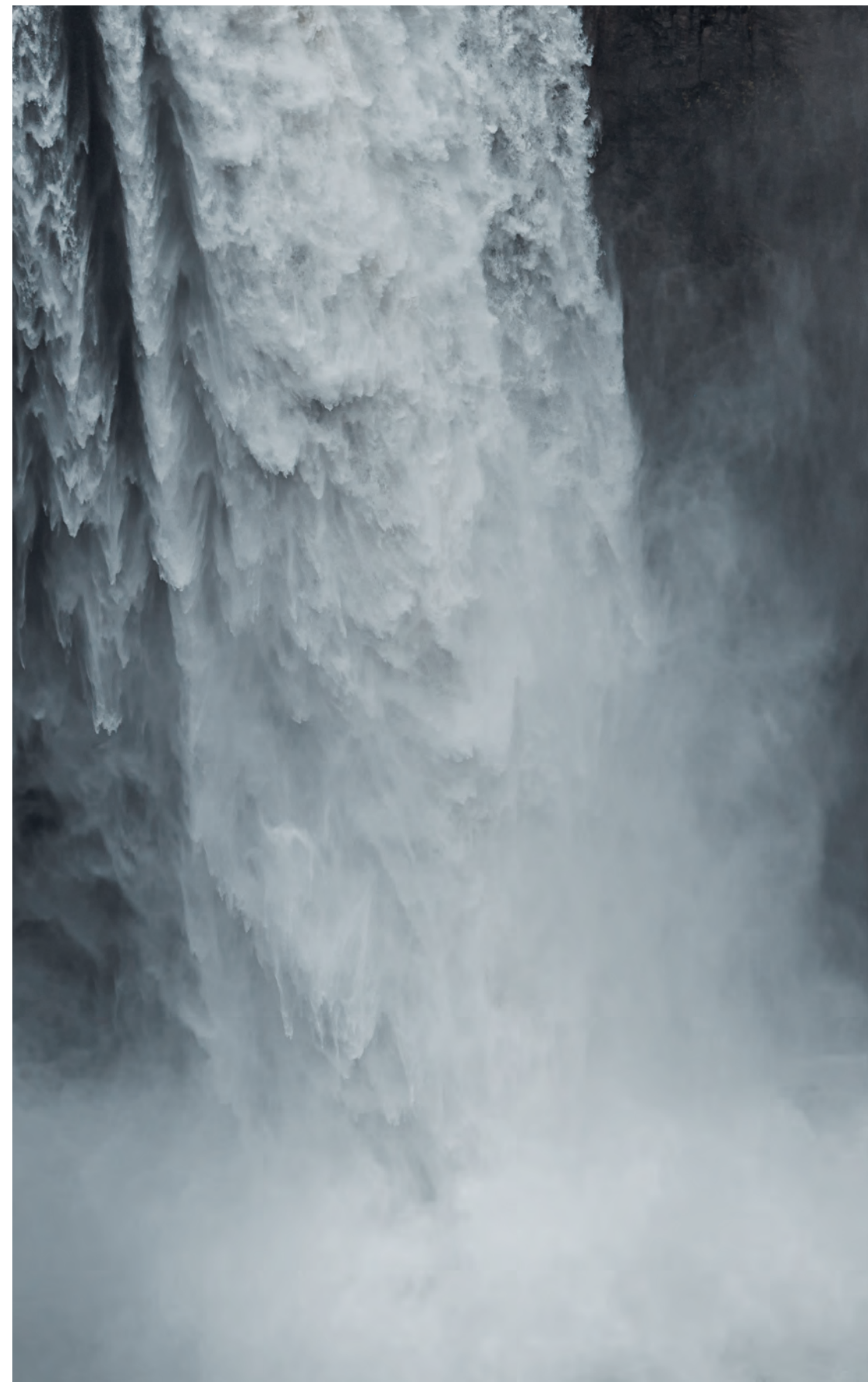



Emotional showers

- Sense Pro
- Aqua
- Infinity
- Vita

Sense Pro

EMOTIONAL SHOWERS

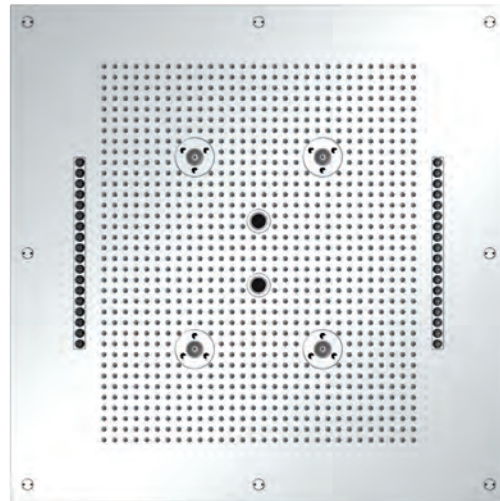

Sense Pro

RGB Lighting



JETS

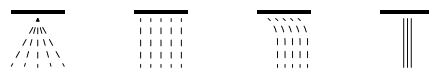

4 SEQUENCES CONTROL PANEL

relax | energy | balance | sport

Dimensions: 70 x 70 cm

Details: p. 340



The Sense Pro emotional shower immerses you in a journey towards your own wellbeing through **4 pre-programmed sequences** (relaxation, energy, balance, sport)

developed by spa managers, combining elements of hydrotherapy, chromotherapy, and aromatherapy.



Aqua

EMOTIONAL SHOWERS

Experience a shower of sensations with AstralPool Aqua emotional shower. Control the different types of jets with the Manual version or surrender to the timed Sequence version.

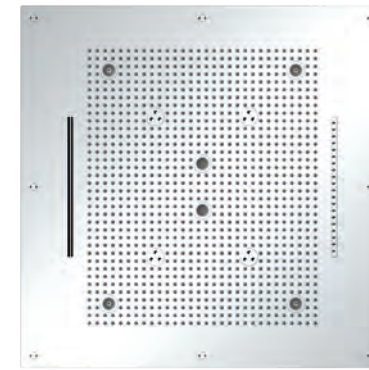

Aqua

RGB Lighting

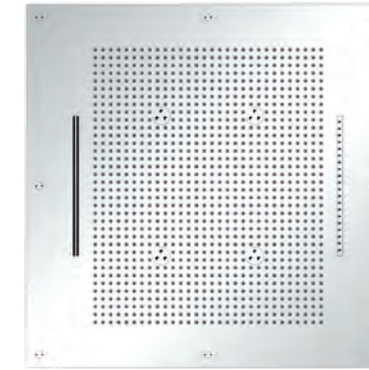

Aqua Nude

No Lighting

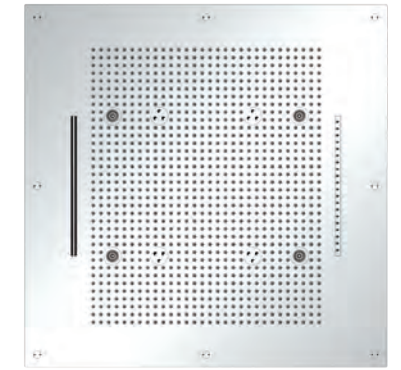
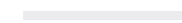

Aqua White

White Lighting



JETS



Manual



Sequence

ACCESSORIES

Dimensions: 70 x 70 cm

Details: p. 341

Infinity

EMOTIONAL SHOWERS

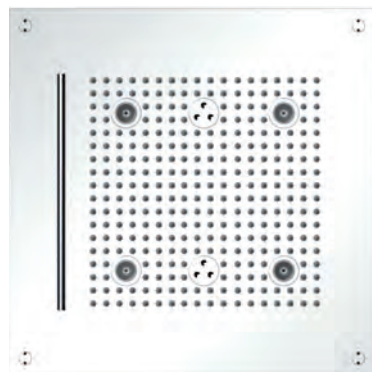

Infinity

RGB Lighting

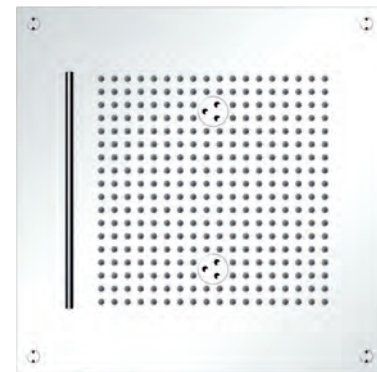

Infinity Nude

No Lighting

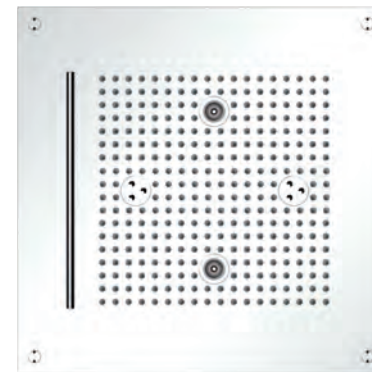
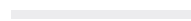

Infinity White

White Lighting



JETS



Manual

ACCESSORIES

Sequence

Dimensions: 42 x 42 cm

Details: p. 342



Let your mind soar to infinite places with AstralPool Infinity Emotional shower.

Control the different types of jets with the Manual version or surrender to the timed Sequence version.



Vita

EMOTIONAL SHOWERS

Revitalize body and mind with Vita Emotional Shower. Manually control the different types of jets.



Vita

RGB Lighting

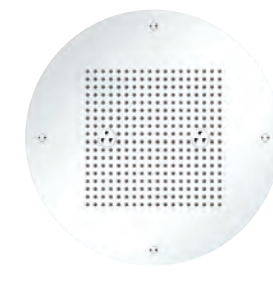

Vita Nude

No Lighting

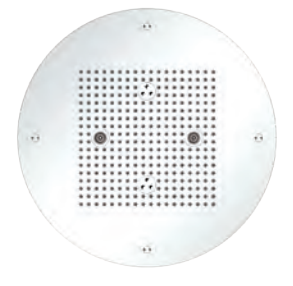
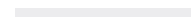

Vita White

White Lighting



JETS

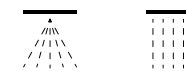

ACCESSORIES

Dimensions: Ø50 cm

Details: p. 343

Accessories
and their symbols.



Sound



Scented
water



Aromatherapy



Additional external
thermostat



Reverse circuit

Everything under control with the Manual and Sequence switches



The difference between the Sequence and Manual models is very simple and lies in their operating modes. The same shower model can be equipped with either, both excellent for an experience tailored to your needs.

This sophisticated switch turns on easily, starting a timed sequence of the various shower jets with just the press of a button in the Sequence models.

The Manual models make it possible to enjoy each individual jet whenever you want; choose your favorite or the one that best adjusts to your needs.

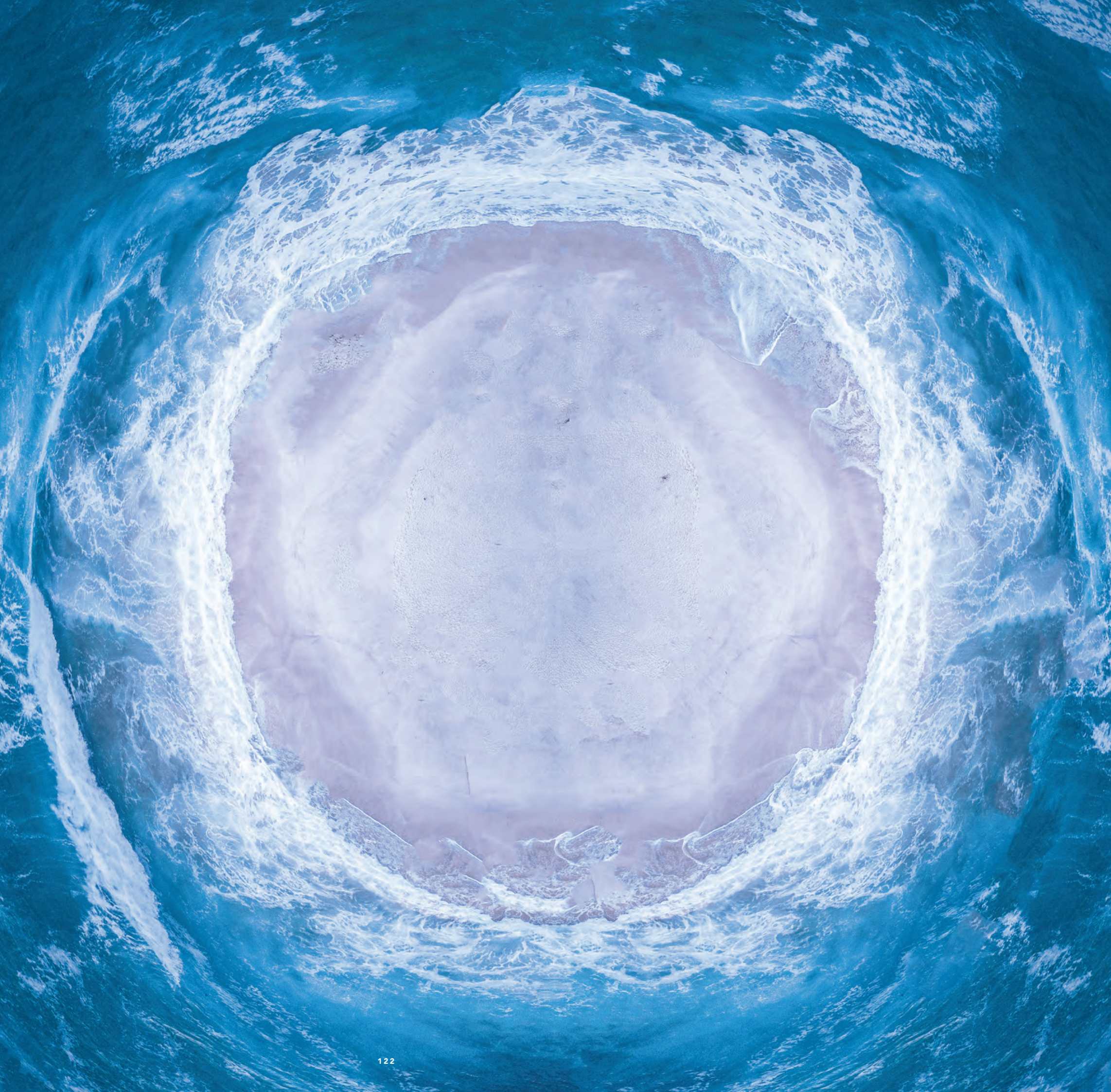

Emotional tunnels

Aqua
Infinity
Vita

Aqua

EMOTIONAL TUNNELS

The Aqua emotional shower tunnel combines four fully programmed water, light, and temperature effects. The perfect fit for designs that incorporate water and moods created by lights, sounds, and fragrances.



RGB Lighting

JETS

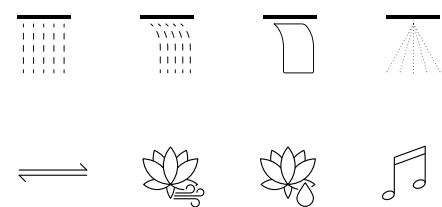

ACCESSORIES



SEQUENCE CONTROL PANEL

Dimensions: 35 x 35 cm

Details: p. 344





Infinity

EMOTIONAL TUNNELS

Infinity Tunnel is the combination of five mini-showers designed not only to relax but to massage the entire body from head to toe. Different types of water jets help relieve tension and tightness in the muscles of the upper body.



—
No Lighting

JETS



SEQUENCE CONTROL PANEL

Dimensions: 15 x 35 cm

Details: p. 345

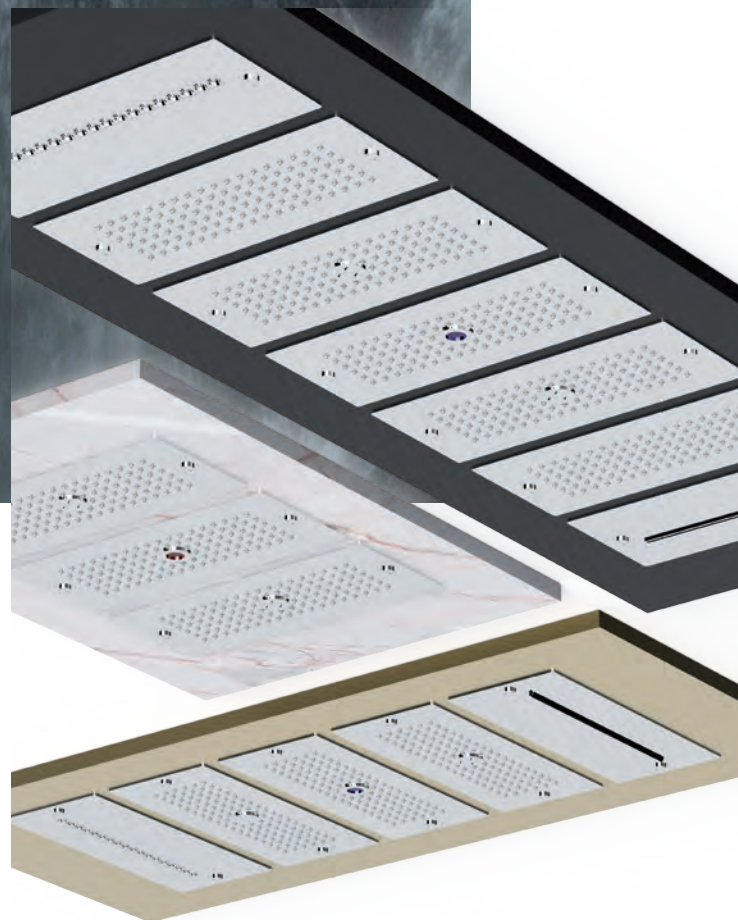
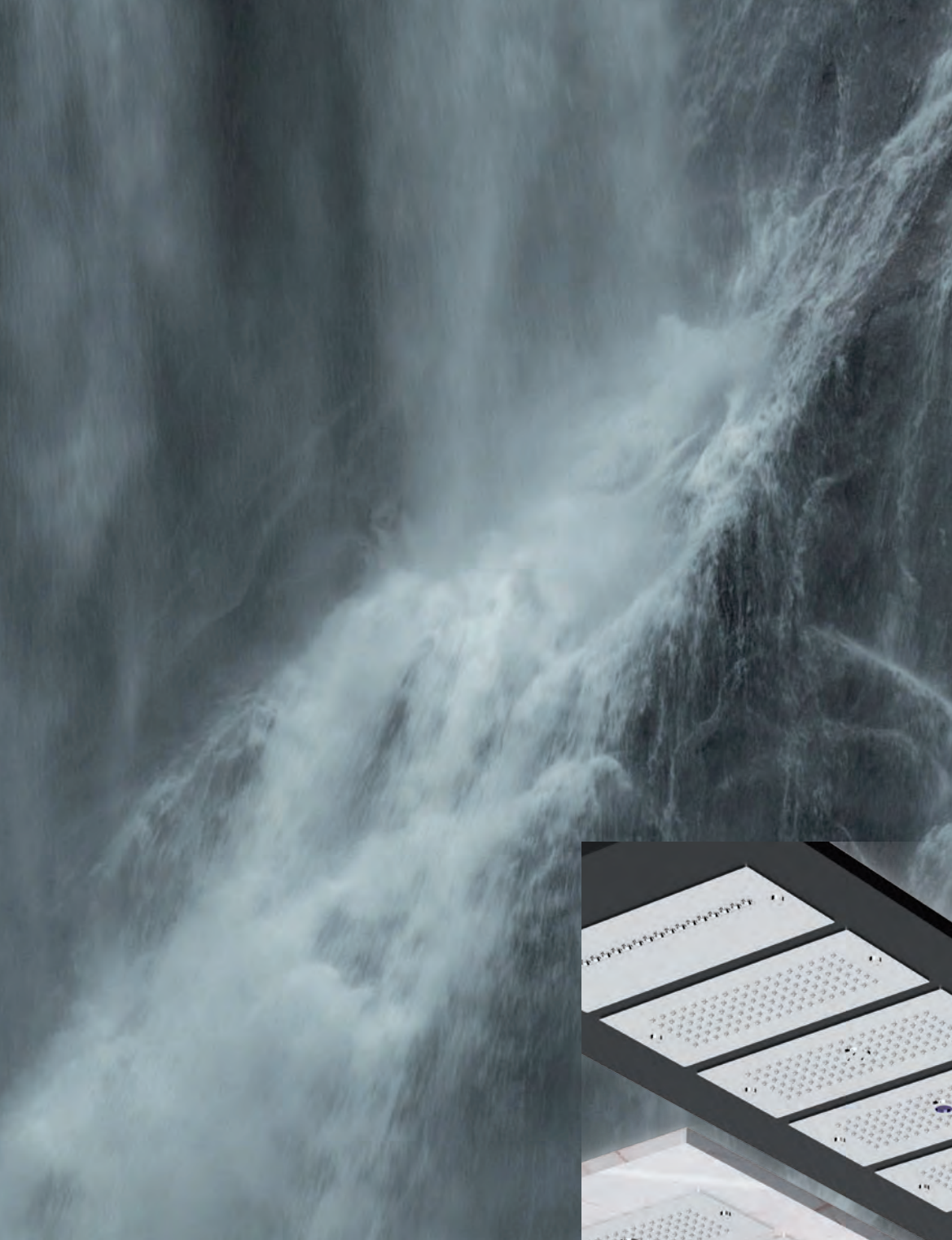

Vita

EMOTIONAL TUNNELS

Vita tunnel combines two mini showers with a stylish central head. This perfect and simple fusion blends light, temperature, and water for an exceptional experience. Install Tune Vita easily and quickly on a pre-formed plate (on request).

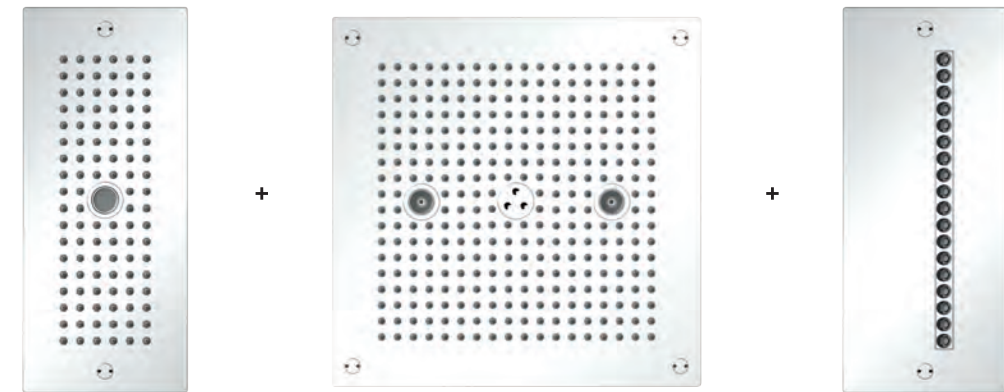

RGB Lighting

JETS

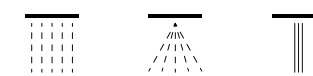

ACCESSORIES



SEQUENCE CONTROL PANEL

Dimensions: 15 x 35 cm | 35 x 35 cm | Details: p. 346



Contrast showers

- Bucket
- Cold
- Hot & Cold

Bucket

CONTRAST SHOWERS

The contrast shower inspired by Tyrolean bucket showers is undoubtedly one of the best ways to deliver temperature contrast after time in a hot room. Abundant cold water has to hit the chest and back for optimal treatment.



—
No Lighting
—

—
Details: p. 348
—

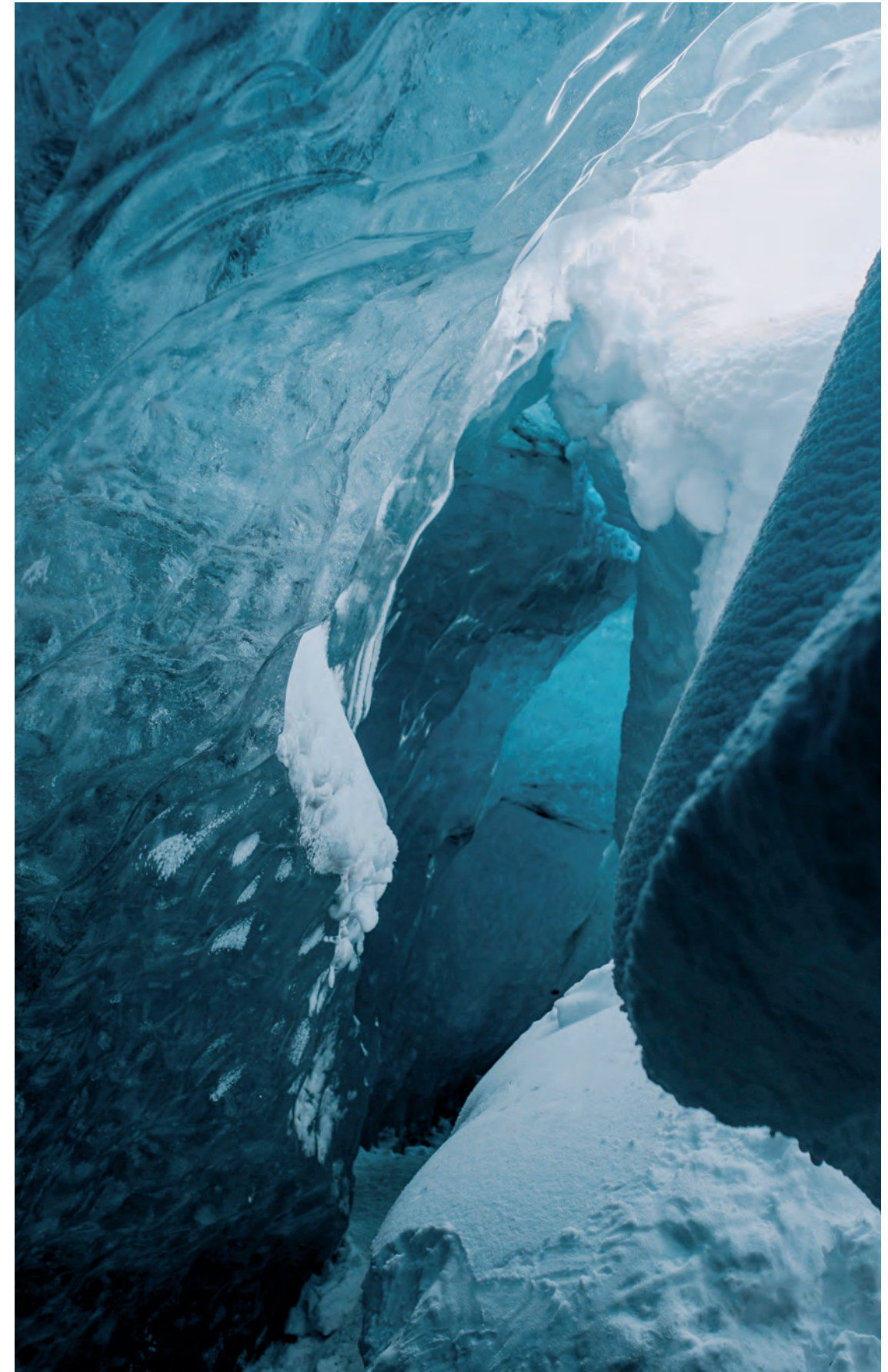

Cold

CONTRAST SHOWERS

The AstralPool cold water body jets for ceiling or wall are the perfect way to create a contrast therapy session after time in the sauna or steam room. Its three spray units are controlled by a timer button located near the shower.



RGB Lighting



JETS



SEQUENCE CONTROL PANEL

Dimensions: Ø7,5 cm

Details: p. 348

Hot & Cold

CONTRAST SHOWERS

Bithermal contrast in a single unit. AstralPool's hot and cold shower consists of 3+3 body jets operated by a timer button located near the shower.

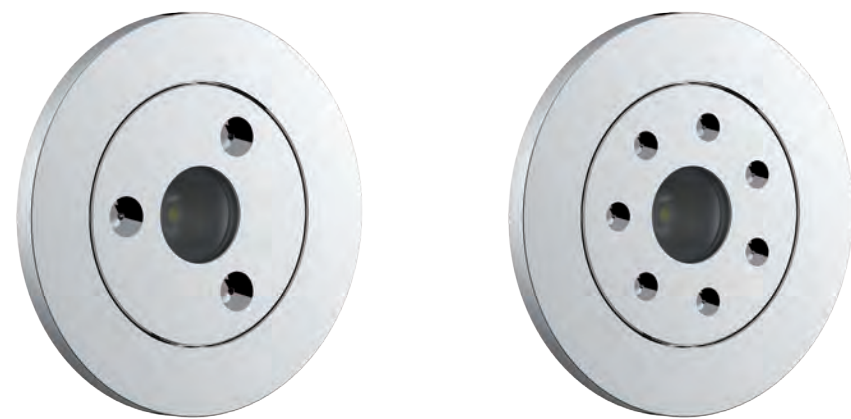

JETS

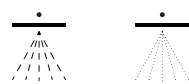

SEQUENCE CONTROL PANEL

Dimensions: Ø7,5 cm

Details: p. 348





Horizon

H O R I Z O N T A L S H O W E R

Horizon, AstralPool's new horizontal shower, makes it possible to experience for the first time the combined effects of a full body massage and a balanced, relaxing, and stimulating emotional journey.

Perfectly adaptable to any environment, the horizontal shower is designed for ceiling installation.



RGB Lighting



JETS



4 SEQUENCES TOUCH PANEL

relax | energy | balance | sport

Dimensions: 108,4 x 30,6 cm

Details: p. 349



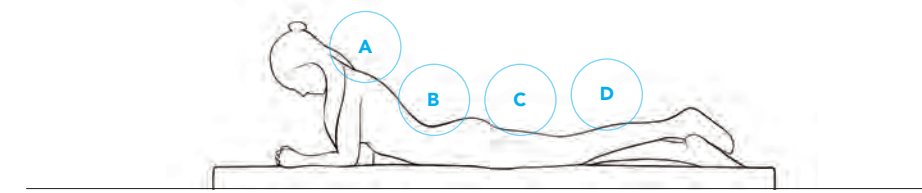
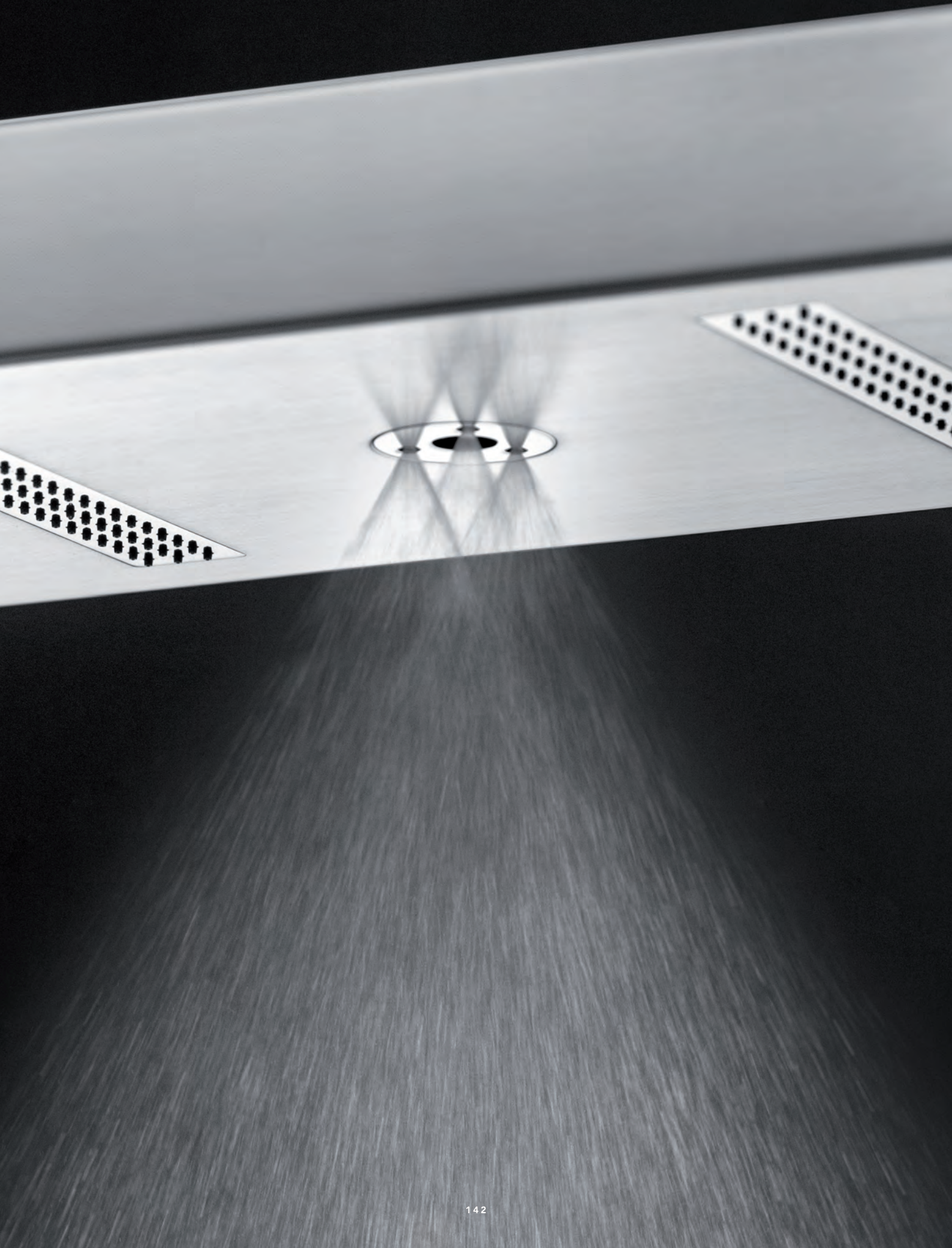

M A S S A G E A R E A

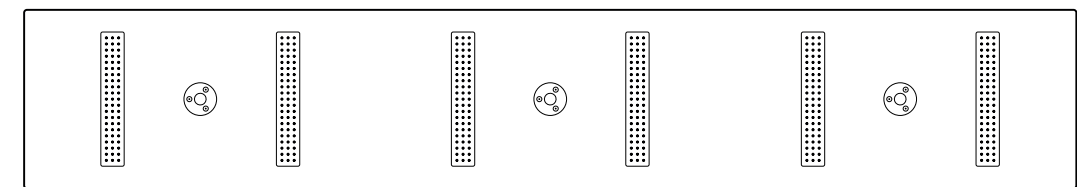

A.
Cervical area

B.
Back area

C.
Lower-back area

D.
Leg area

FEATURES

FULL-BODY MASSAGE

The shower's horizontal position provides the same effects and benefits of a complete massage.

4 PROGRAMS

Four massage programs that combine rain jet, mist, and RGB LED light.

PRIVATE SPA

The horizontal shower reproduces the experience of a truly bespoke spa treatment in a single product.

MANUAL AND PROGRAMMABLE CONTROLS

Horizon is equipped with a manual touch control to manage programs and individual jets.



Kneipp
Kneipp Path

Kneipp

KNEIPP PATH

The Kneipp route aims to restore ultimate mental and physical balance to strengthen the body and help it fight a wide range of diseases.



RGB Lighting



JETS

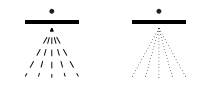

ACCESSORIES

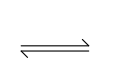

Dimensions: 3m | 5m | 9m

Details: p. 350



Bespoke

TAYLOR MADE SHOWERS

Fluidra offers customized solutions, putting its expertise and skills at your service to create unique and tailor-made products. From finishes to sizes and multiple functions, Fluidra will listen to any request and craft the product to meet every need.

1
SIZE



2
FUNCTION

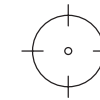

3
FINISHES



4
COMPOSITION

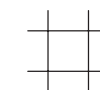

5
MUSIC



Taylor Made Showers

CUSTOM SOLUTIONS

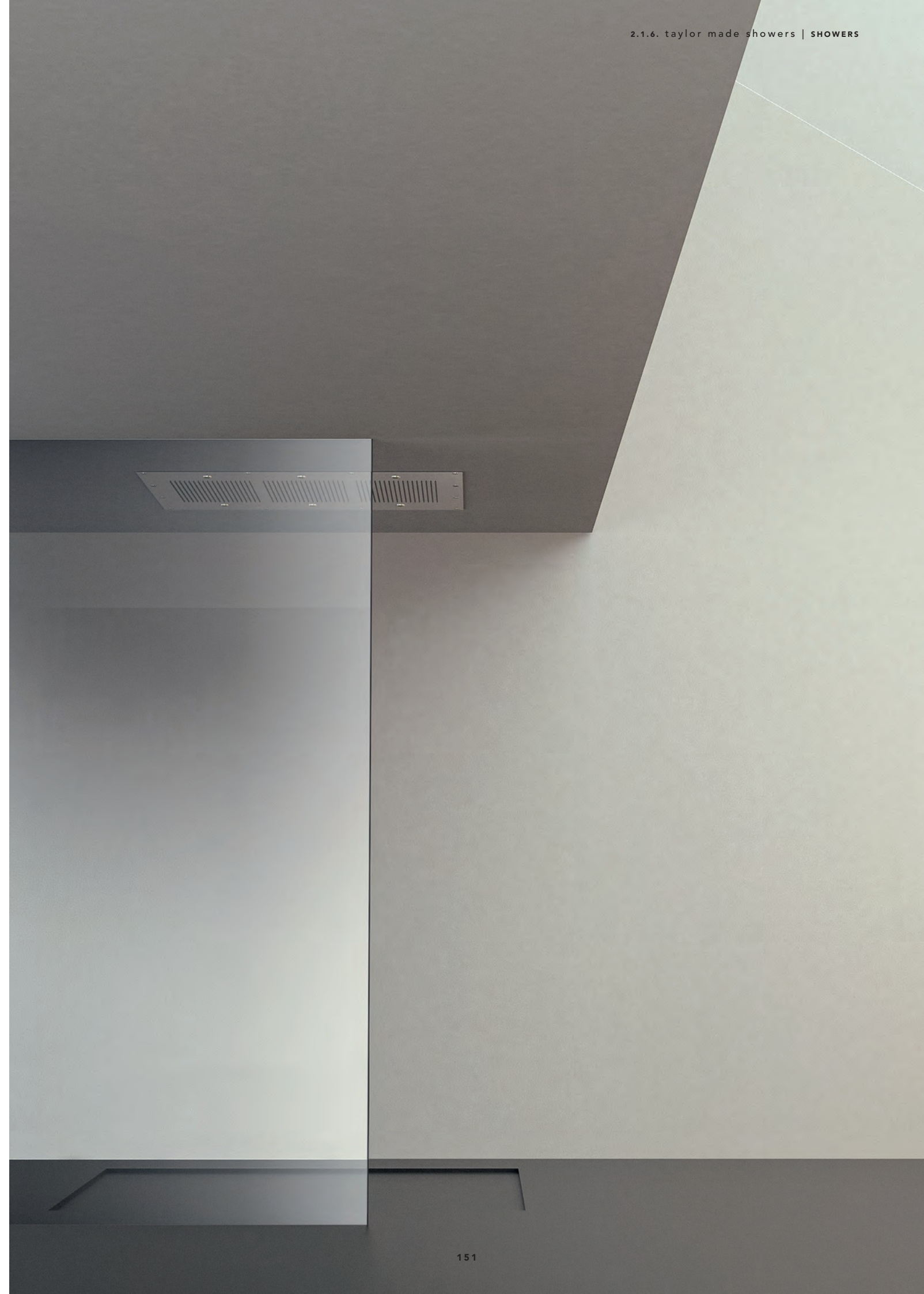
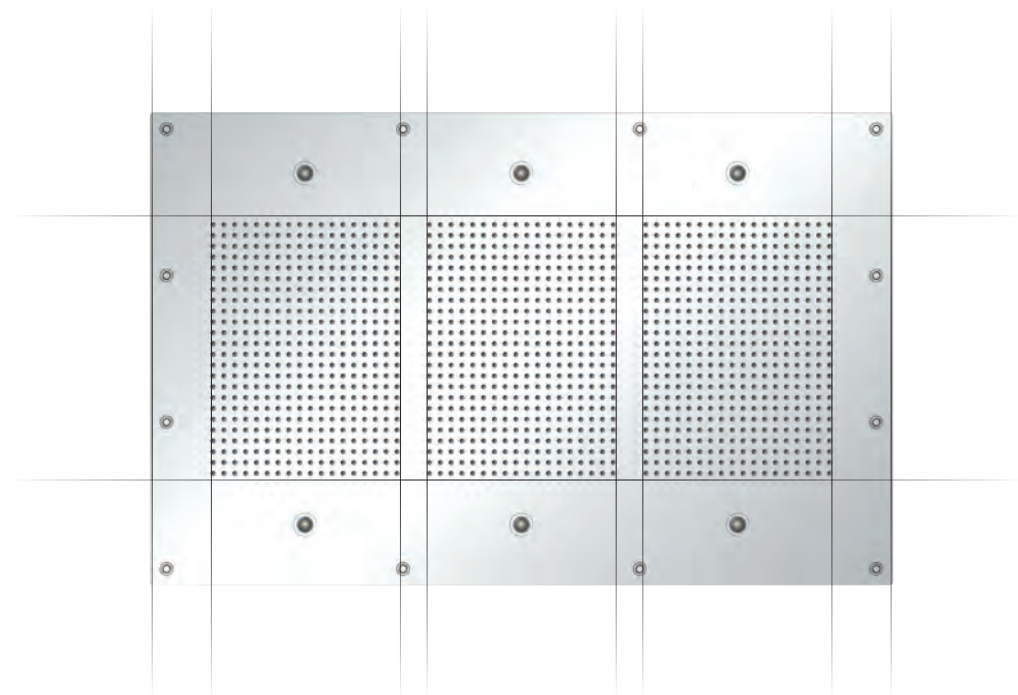



W A T E R Z O N E

2.2

Mini contrast pools

In the late 5th century B.C., following the example of the Greeks, the popular Roman baths incorporated cold rooms called "Frigidariums", where bathers would finish their circuit after passing through hot rooms like the steam room or the hot pool. We preserve these rituals of old, fully confident in the health benefits that contrast therapy has on the body. Not only is it good for the skin, but it also increases metabolism, blood flow, and stimulates the widening and narrowing of the blood vessels.

Limiting use to no longer than 2 minutes is recommended.

One

MINI CONTRAST POOLS



One is crafted from a single piece of AISI-316L 2-mm-thick satin-finish stainless steel . Elegant and robust design, careful finishes, and first-class materials make ONE a perfect choice for any "Frigidarium" .

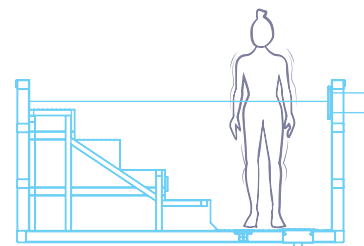

Dimensions: 218 x 98 x 108 cm.
Details: p. 351





Two

MINI CONTRAST POOLS



Two is crafted from a single piece of AISI-316L 2-mm-thick satin-finish stainless steel. Elegant and robust design, careful finishes, and first-class materials. It includes an entrance staircase and an exit staircase that facilitate the flow of people through the space.

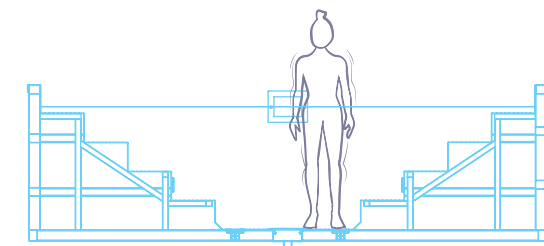

Dimensions: 358 x 98 x 108 cm

Details: p. 351



W A T E R Z O N E

2.3

Vitality Pool

Opulence and elegance. AstralPool's Vitality swimming pools are crafted in a single piece of satin-finish stainless steel with a non-slip bottom. Ready to connect, minimizes installation times and eliminates construction work.



Optimal

VITALITY POOL



Crafted in a single piece of 2-mm-thick satin-finish stainless steel with a non-slip bottom. This overflow model features LED projectors and a three-step staircase.

Dimensions (m):

5 x 3 x 1,2

7 x 3 x 1,2

9 x 3 x 1,2

12 x 3 x 1,2

Details: p. 352-356

Comfort

VITALITY POOL

Crafted in a single piece of 2-mm-thick satin-finish stainless steel with a non-slip bottom. This overflow model features LED lighting, integrated staircase, and multiple hydromassage accessories.



Dimensions (m):

7 x 3 x 1,2

9 x 3 x 1,2

12 x 3 x 1,2

Details: p. 352-356



Wellness

VITALITY POOL



Dimensions (m):

- 5 x 3 x 1,2
- 7 x 3 x 1,2
- 9 x 3 x 1,2
- 12 x 3 x 1,2

Details: p. 352-356



Crafted in a single piece of 2-mm-thick satin-finish stainless steel with a non-slip bottom.

This overflow model features LED lighting, integrated staircase, and multiple hydromassage accessories.



Sport

VITALITY POOL

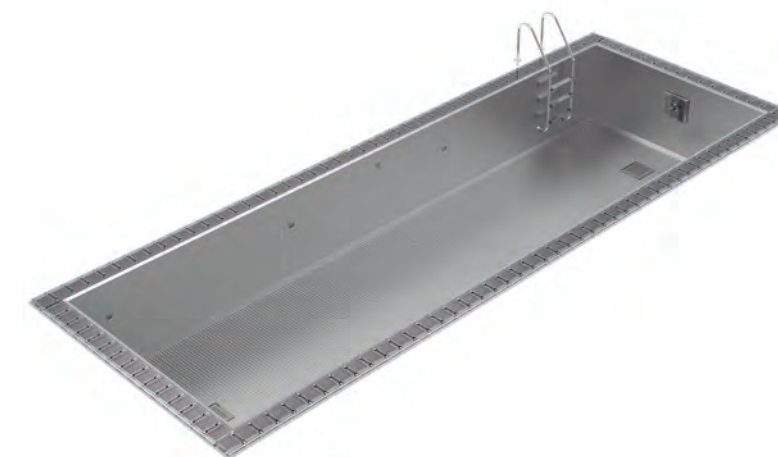

Crafted in a single piece of 2-mm-thick satin-finish stainless steel with a non-slip bottom. This overflow model features LED lighting, a three-step staircase and a swimming upstream equipment.

Dimensions (m):

5 x 3 x 1,2

7 x 3 x 1,2

9 x 3 x 1,2

12 x 3 x 1,2

Details: p. 352-356



Playa is an elegant mini-pool created from great Italian design. Its soft hydromassage, hot water and its pleasant hand-woven fibers invite you to relax in a deep well-being both indoors and outdoors.

Playa Living, the evolution of the Playa model, incorporates soft cushions and sofas. This mini-pool transforms your space into a complete oasis of relaxation adding an elegant touch of sophistication.

Playa / Playa living

VITALITY POOL / MINI POOL



Dimensions (m):

2,2 x 2,2 x 0,7

3,2 x 2,2 x 0,7

4,2 x 2,2 x 0,7

Details: p. 352-356



W A T E R Z O N E

2.4

Hydro Leisure Elements

Feel the pleasure of deeper relaxation.

There are many variations of hydrotherapy, with spa water elements providing remarkable benefits that both relax and stimulate the nervous system.

AstralPool's range of hydrotherapy products, made of stainless steel, includes both outdoor pool elements and indoor sets. The clean, elegant design is paired with the finest finishes.

It releases the body's tension in a massage circuit using pressurized water.

Pool surround Cascade

HYDRO LEISURE ELEMENTS



A cascade for the pool surround designed to create an intense yet deeply relaxing curtain of water.

This accessory is made from mirror-polished AISI 316 stainless steel and has to be ordered with the anchor plate for secure installation.

Complementary accessories

- Self-priming pump with flow rate of 34 m³/h at 10 m.w.c.
- Drainage system featuring 110 mm diameter stainless steel grill.
 - Piezoelectric push button.

Details: p. 357





Pool surround Water Jet

HYDRO LEISURE ELEMENTS

Water jet for pool surround, featuring swan-neck shaped cylindrical section, providing a high-pressure jet of water for a relaxing cervical massage.

This accessory is made from polished AISI -316 stainless steel and has to be ordered with the anchor plate for secure installation.

Complementary accessories

- Self-priming pump with flow rate of 10 m³/h at 14 m.w.c.
- Circular drainage system with 75 mm diameter outlet.
- Piezoelectric push button.

Details: p. 357

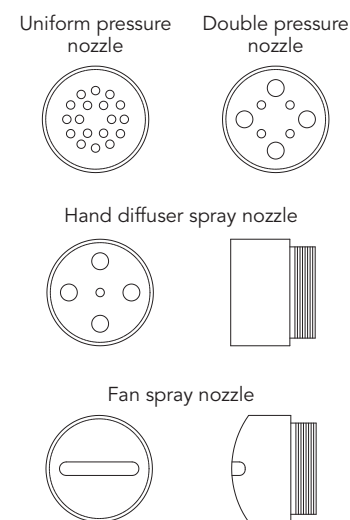

Wall-mounted Water Jet

HYDRO LEISURE ELEMENTS



Wall-mounted water jet with cylindrical cross-section. Designed to produce multiple high-pressure water jets for a back and shoulder massage of medium intensity, depending on model. This accessory is manufactured from polished AISI-316 stainless steel. Anchor system for wall mounting.

Complementary accessories

- Self-priming pump with flow rate of 10 m³/h at 8 m.w.c.
- Circular drainage system with 2 1/2" W BSP diameter outlet.
- Piezoelectric push button.

Details: p. 358

Cervical Massage

HYDRO LEISURE ELEMENTS



The Astralpool's Neck massage has 6 jets oriented with focus on the cervical area. Its medium massage intensity allows its use for a long time. Ideal to install on the seating area. It is an element made of polished stainless steel AISI-316.

Complementary accessories

- Self-priming pump with flow rate of 10 m³/h at 8 m.w.c.
- Circular drainage system with 2 1/2" W BSP diameter outlet.
 - Piezoelectric push button.

Details: p. 358





Massage Nozzles 3-Set

HYDRO LEISURE ELEMENTS

Set comprising three massage effect nozzles, using a combination of water and air to stimulate calves, thighs and hips. These are hung in a vertical arrangement on the wall of the pool, at a height of 30, 60 and 90 cm from the pool bottom. The set is completed with a polished rounded stainless steel handrail which can either be attached to the pool surround or the wall of the pool itself. This handrail serves two functions -it gives pool users something to hold onto whilst allowing air to enter through holes situated along its length which is then directed to the nozzle by the so-called Venturi effect.

Complementary accessories

- Self-priming pump of 50 m³/h at 10 m.w.c.
- Piezoelectric push button.

Details: p. 360



Hydromassage Jet

HYDRO LEISURE ELEMENTS

Hydromassage jet system, specifically designed to be situated in areas where there are benches, water channels etc. Wherever an intense, localized massage is required. The acceleration of the water jet resulting from the Venturi effect creates hundreds of thousands of tiny air bubbles which further intensify the massage effect.

This accessory is 100% mirror-polished AISI-316 stainless steel with interchangeable nozzles.

Complementary accessories

- High water flow suction grill depending on the number of nozzles used.
- Piezoelectric push button.

Details: p. 361

Hydromassage Mini Jet

HYDRO LEISURE ELEMENTS



Hydromassage jet system, specifically designed to be situated in areas where there are benches, water channels etc. Wherever an intense, localized massage is required. The acceleration of the water jet resulting from the Venturi effect creates hundreds of thousands of tiny air bubbles which further intensify the massage effect.

Complementary accessories

- High water flow suction grill depending on the number of nozzles used.
- Piezoelectric push button.

Details: p. 362

Dynamic Hydro-channel Jet

HYDRO LEISURE ELEMENTS

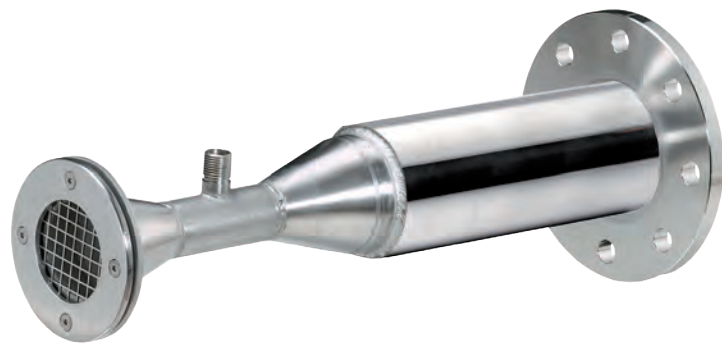

Comprised of a set of water jet nozzles in mirror-polished stainless steel which, when situated and directed correctly, provide a flow of water using recycled pool water. Creates water currents of varying strengths.

Complementary accessories

- Self-priming pump of 50 m³/h at 10 m.w.c.
- Piezoelectric push button.

Details: p. 362

Massage grills

HYDRO LEISURE ELEMENTS



Pool floor massage effect air bubble generator. Cylindrical polished stainless steel accessory to be installed in pool floors, specially prepared for concrete pools. Available for liner installation on request.

Dimensions (mm): ø300

300 x 300 / 500 x 500 / 675 x 675 / 750 x 750

Complementary accessories

- Air blower according to reference.
 - Siphon circuit jet system.
- 75 mm Ø PN-10 PVC water jet tubing.
 - Piezoelectric push button.

Details: p. 363



Bubble Snake

HYDRO LEISURE ELEMENTS

Elongated pool floor massage effect air bubble generator. The casing is made from polished stainless steel in the form of a long snake, to be installed in pool floors. The steel sheeting has holes along its length to allow the bubble to escape and create the desired effect.

Complementary accessories

- Air blower with flow rate of 140 m³/h at 120 mbar.
- Siphon circuit jet system.
- Piezoelectric push button.

Details: p. 364



Hydromassage Bench

HYDRO LEISURE ELEMENTS

Elongated massage effect air bubble generator for pool floor and/or bench for feet and buttocks.

Polished AISI 316 rectangular or semi-circular stainless steel casing accessory for mounting on pool bottoms or benches. The steel sheeting has holes along its length to allow the bubble to escape and create the desired effect.

Dimensions (mm): 300 / 600 / 1200

Complementary accessories

- Air blower according to reference.
- Siphon circuit jet system.
- Piezoelectric push button.

Details: p. 365

Air Beds

HYDRO LEISURE ELEMENTS



Ergonomically designed massage accessory with air jets in the back, lumbar and leg regions. The bed is comprised of stainless steel casing with air holes situated in the key massage areas.

The range includes both a single and double model.

Complementary accessories

- Air blower with flow rate of 80 m³/h at 100 mbar.
 - Siphon circuit jet system.
 - Piezoelectric push button.

Details: p. 366

Hydromassage Lounger

HYDRO LEISURE ELEMENTS



Manufactured in AISI-316 stainless steel and ergonomically designed to provide maximum comfort. The system is based on air which is injected through the base of the lounger, providing a muscle-relaxing massage.

Available in two versions: embedded or installed with column.

Dimensions (mm):

to embed: 1450 / 1700
for column: 1450 / 1700

Accessories

L500 Column
Concrete column anchor
Prefabricated pool column anchor

Complementary accessories

- Air blower with flow rate of 150 m³/h at 100 mbar.
- Piezoelectric push button.

Details: p. 367



Hydromassage Beds

HYDRO LEISURE ELEMENTS

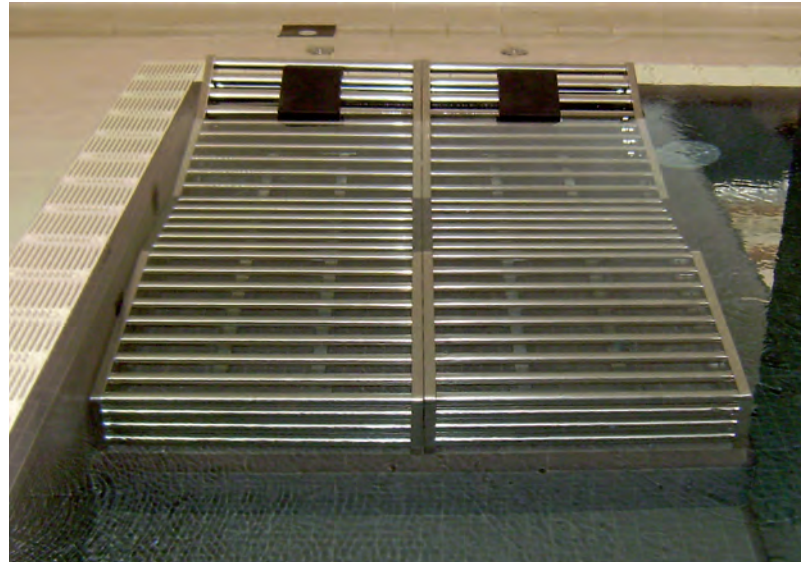

An elegant, modern design made of stainless steel tubes. Its flexible design allows as many beds as desired to be linked in parallel, achieving variable widths adaptable to each project.

Necessary elements for massage bed installation

Air circuit:

- Air blower with flow rate of 80 m³/h at 100 mbar.
 - Siphon circuit jet system.
 - Piezoelectric push button.

Details: p. 369



Spaecial Hydromassage Beds

HYDRO LEISURE ELEMENTS

Stainless steel ergonomic waterbed for individual use. Composed of 200 air micro-outlets which provide a relaxing and pleasant massage. Easy installation.

Necessary elements for massage bed installation

Air circuit:

- Air blower with flow rate of 80 m³/h at 100 mbar.
 - Siphon circuit jet system.
 - Piezoelectric push button.

Details: p. 369

High flow Suction Grills

HYDRO LEISURE ELEMENTS



An attractive element manufactured in AISI-316 stainless steel, comprised of a frame and modular grill, this piece has been specially designed to protect the suction tubes which feature in high-flow grills.

Dimensions (mm): 300x100 / 600x200 / 1200x200

Details: p. 370

Push buttons

HYDRO LEISURE ELEMENTS
ACCESSORIES

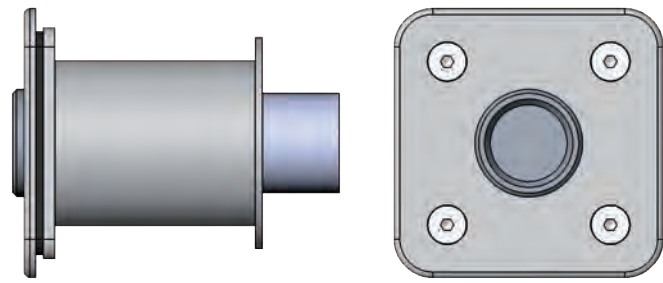

A new piezoelectric push button with an attractive design.

It is specially designed to work in adverse environments. Its high resistance helps reduce maintenance costs. Despite IP-68 protection, immersion is not recommended.

Details: p. 374

Water Effect Timer

HYDRO LEISURE ELEMENTS
ACCESSORIES

This accessory allows for timed shut off of water effects such as cascades, water jets etc, meaning that they do not have to be permanently connected. This is activated via a piezo-electric switch situated near the pool. When the switch is pressed, a relay circuit is activated which starts up the mechanism and the timer, which may be programmed for a period of time from 0 to 30 minutes. Once this time is up, the relay system automatically disconnects. The timer also permits simple on/off operation, without the timer function. In this case it needs to be switched to "Manual" mode. The timer LEDs indicate installation activity:

- Red LED = Effect deactivated
- Green LED = Effect activated

The terminal also features two additional outlets for push button LED indicators.



Details: p. 374



Air Blowers

HYDRO LEISURE ELEMENTS



Air pump designed for spas, baths, hydromassage installations and similar which produces a constant stream of air bubbles at medium and high air volume

levels. It can also be used to stir up the filter bed, for example in back wash cycles where a low intensity air current is required.

Details: p. 372





W A T E R Z O N E

2.5

Spas

Sit back, relax, and enjoy...

Water has also been essential for human survival, and the benefits of hydrotherapy have been known since ancient times.

Today, hydrotherapy is a natural solution used to alleviate and treat conditions including stress, anxiety, and insomnia, symptoms of our hectic lives.

Hydrotherapy helps stimulate blood circulation and eliminate toxins from the body and is an excellent tool for treating a range of diseases, as well as bone and muscle injuries.

Don't miss a thing. Everything you need to know about our jets and spa accessories.



WATER JETS

Effective and relaxing.
The pressurized water
jet releases and relieves
localized muscle tension.



AIR JETS

Soft and delicate. The jet
pushes air into water to
create a mix of bubbles
that provide a tingling,
rejuvenating sensation.



LIGHTING /LED

Underwater white/RGB
lighting device.



PIEZOELECTRIC SENSOR

Switch for the spa's
hydrotherapy system



2.5.1.5. Zeus
2.5.1.6. Apolo

2.5.1.3. Venus
2.5.1.4. Neptuno

2.5.1.1. Vulcano
2.5.1.2. Mercurio



W A T E R Z O N E

2.5.1

Stainless steel spas

AstralPool's stainless steel spas create unique, exclusive, and elegant spaces to balance body and mind.

Aligned with nature and an environmental approach, these spas are a completely sustainable product, 100% reusable and recyclable, which reduces environmental impact and the spa's footprint.

Stainless steel goes beyond elegance and sustainability to deliver excellent durability and resistance (it erodes less over the years).

Highly hygienic and with outstanding sealing, water is kept clean for long periods of time, reducing the use of chemicals.

All our designs are suitable for both indoor and outdoor use.

Vulcano

STAINLESS STEEL SPAS

The Vulcano spa has 6 seats (6 / -). Manufactured in one piece in satin-finish AISI-316L stainless steel with a thickness of 2 mm. The seats have different types of hydromassage in the lumbar and calf areas.

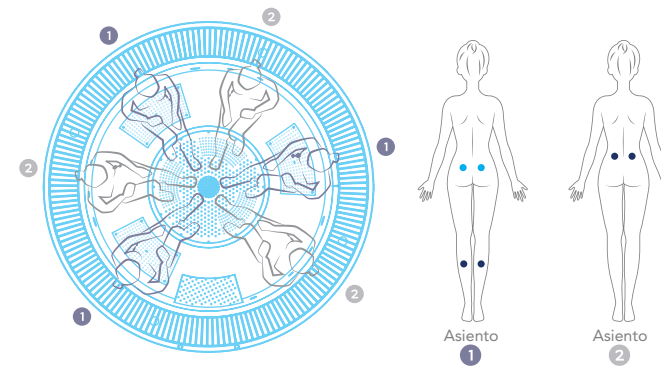

FEATURES



12 15 3 2

Dimensions: Ø 230 x 90 cm

Details: p. 376

Mercurio

STAINLESS STEEL SPAS

The Mercurio spa has 4 seats (2/2). Manufactured in one piece in satin-finish AISI-316L stainless steel with a thickness of 2 mm. It has 2 beds of corporal hydromassage, wooden headrest and 2 seats with hydromassage on the back and calves.

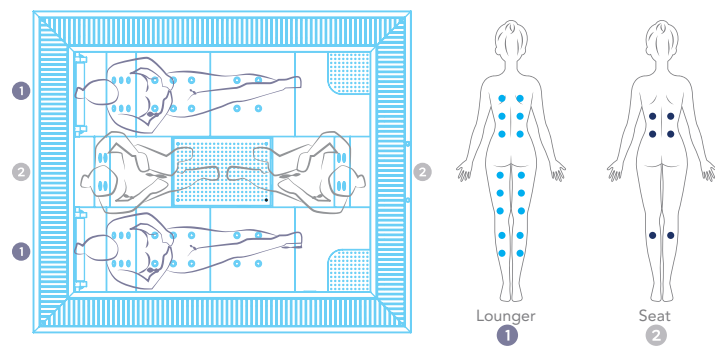
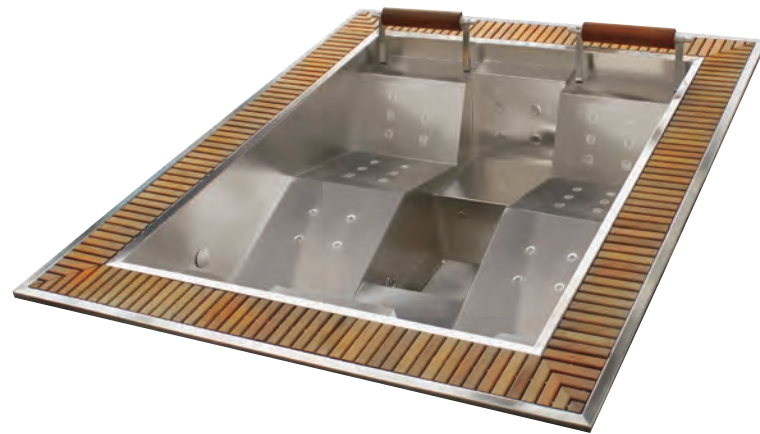

FEATURES

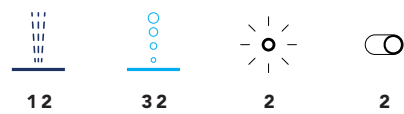

Dimensions: 270 x 230 x 90 cm
Details: p. 376



Venus

STAINLESS STEEL SPAS

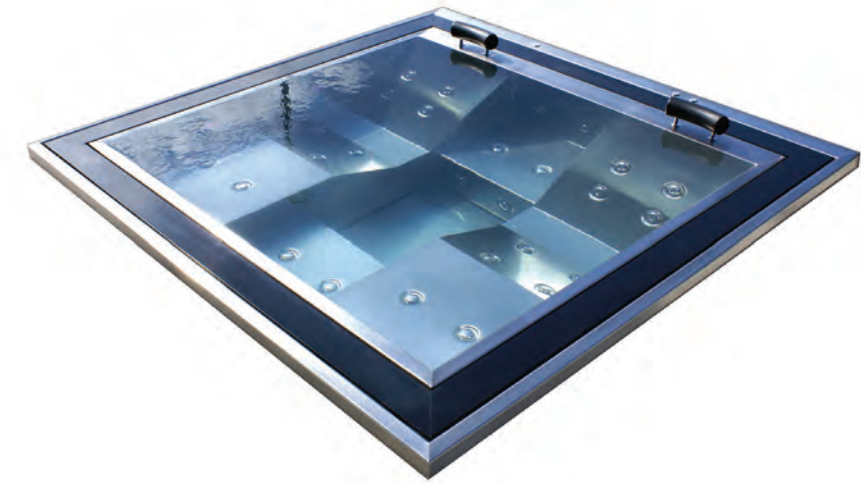

The Venus spa has 4 seats (2/2). Manufactured in one piece in satin-finish AISI-316L stainless steel with a thickness of 2 mm. It has 2 corporal hydromassage, beds, a padded headrest and 2 seats with hydromassage on the back and legs. Spa with overflow channel.

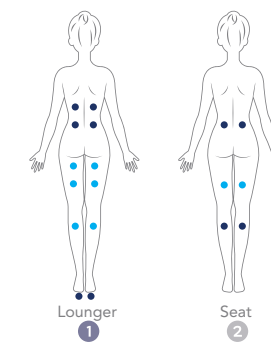
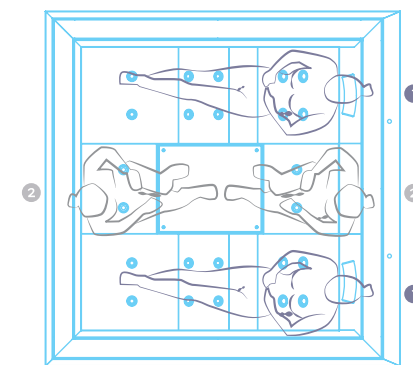

FEATURES

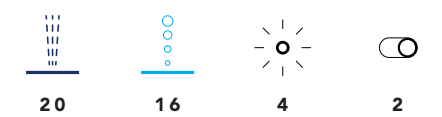

20 16 4 2

Dimensions: 211 x 211 x 90 cm

Details: p. 376



Neptuno

STAINLESS STEEL SPAS

The Neptuno spa has 5 seats (5/-). Manufactured in one piece in satin-finish AISI-316L stainless steel with a thickness of 2 mm. It has 5 seats with different types of hydromassage in back and legs.

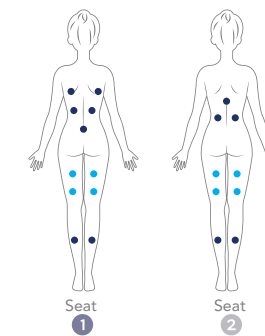
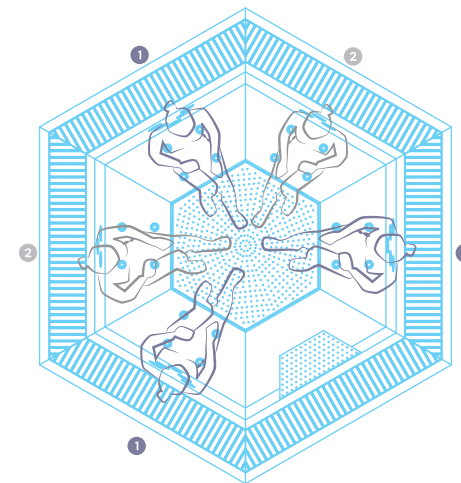

FEATURES

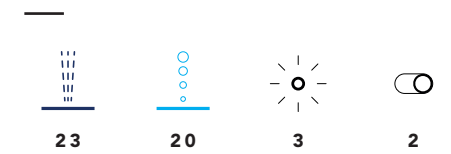

Dimensions: 254 x 220 x 100 cm

Details: p. 376

Zeus

STAINLESS STEEL SPAS

The Zeus spa has 7 seats (5/2). Manufactured in one piece in satin-finish AISI-316L stainless steel with a thickness of 2 mm. It has 2 corporal hydromassage, beds, a padded headrest and 5 seats with hydromassage on the back and legs. Spa with overflow channel.

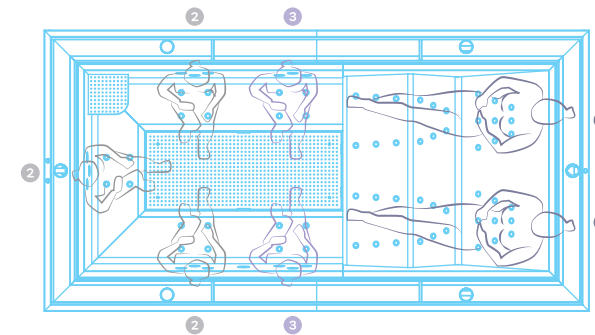
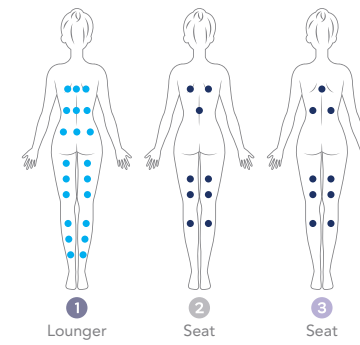

FEATURES



Dimensions: 4,21 x 2,10 x 1,04 m
Details: p. 377



Apolo

STAINLESS STEEL SPAS

The Apolo spa is manufactured in one piece in satin-finish AISI-316L stainless steel. Thickness of 2 mm. With overflow channel.

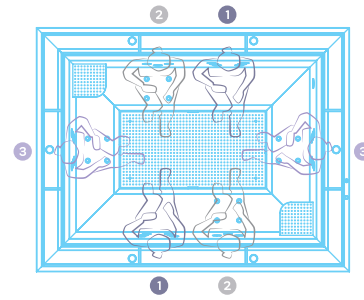

FEATURES APOLO 6

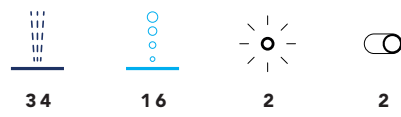

Dimensions: 2,84 x 2,21 x 1,18 m
Details: p. 377

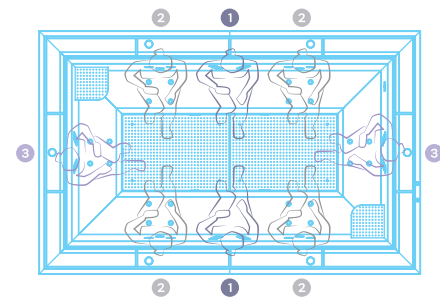

FEATURES APOLO 8



Dimensions: 3,47 x 2,21 x 1,18 m
Details: p. 377

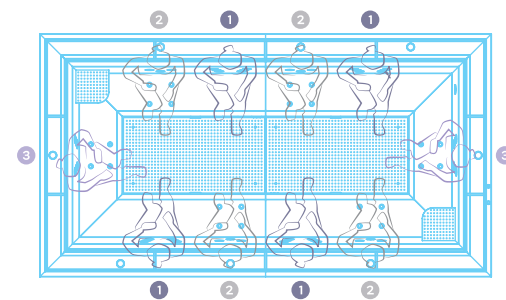

FEATURES APOLO 10



Dimensions: 4,11 x 2,21 x 1,18 m
Details: p. 377

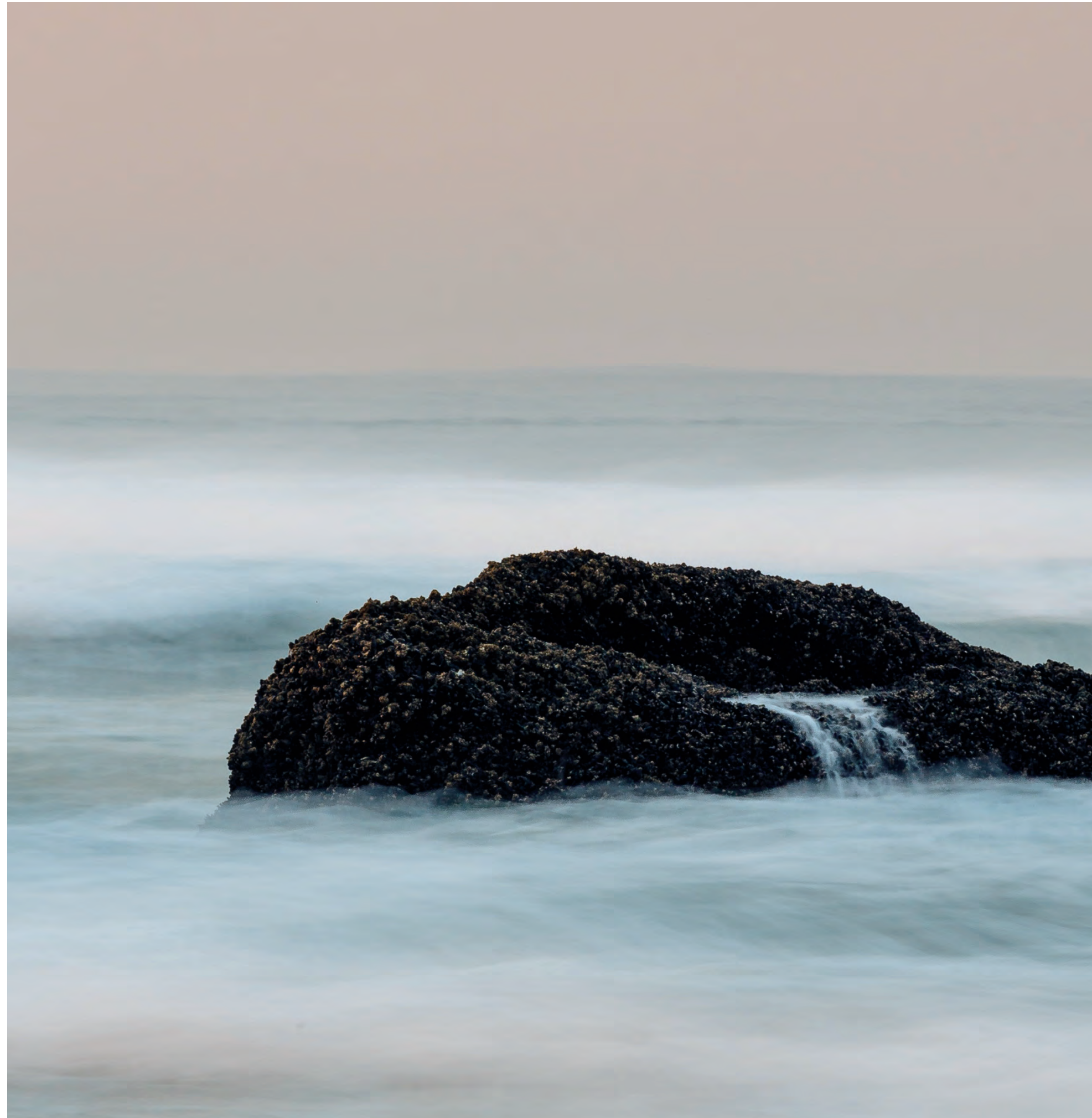
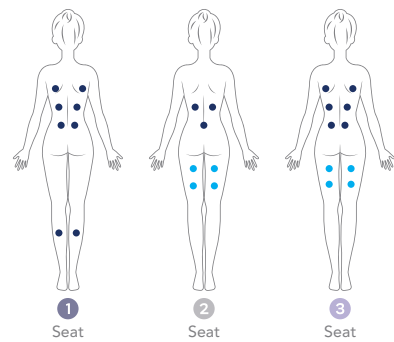

2.5.2.7. Coliseum

2.5.2.5. Verona
2.5.2.6. Olympia

2.5.2.3. Roma
2.5.2.4. Tokyo 70

2.5.2.1. Odisea 20
2.5.2.2. Mirage 40



W A T E R Z O N E

2.5.2

Acrylic spas

Premium finish

All of our spas are made with the finest materials that guarantee optimal performance and product durability.

Systems with added value

Innovation and continuous improvement. Two cornerstones that define our teams. At AstralPool we go a step beyond basic hydromassage to offer a much broader experience that includes chromotherapy in the shower sessions.

Professional filtration

AstralPool's acrylic spa filtration systems are designed for heavy-duty use. The size of each pump ensures greater durability and reliability. Water is filtered through professional filter pumps and sand filters, complying with the strictest regulations.

Odisea 20

ACRYLIC SPAS

The Odyssey 20 is a 5-user spa (5 seats + 0 loungers), designed for public or professional use.

It is a spa designed to be recessed or covered.
It requires filtering equipment and a compensation tank.



FEATURES

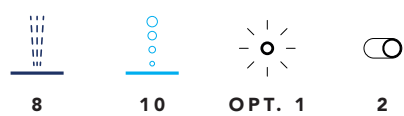

Dimensions: Ø 230 cm

Details: p. 380



Mirage 40

ACRYLIC SPAS



The Mirage 40 is a 6-user spa (6 seats + 0 loungers), designed for public or professional use.

It is a spa designed to be recessed or covered.
It requires filtering equipment and a compensation tank.

FEATURES



26

12

1

2

Dimensions: Ø 250 cm

Details: p. 380

Roma

ACRYLIC SPAS

The Roma spa is a 9-user spa (9 seats + 0 loungers), designed for public or professional use.

It is a spa designed to be recessed or covered.

It requires filtering equipment and a compensation tank.

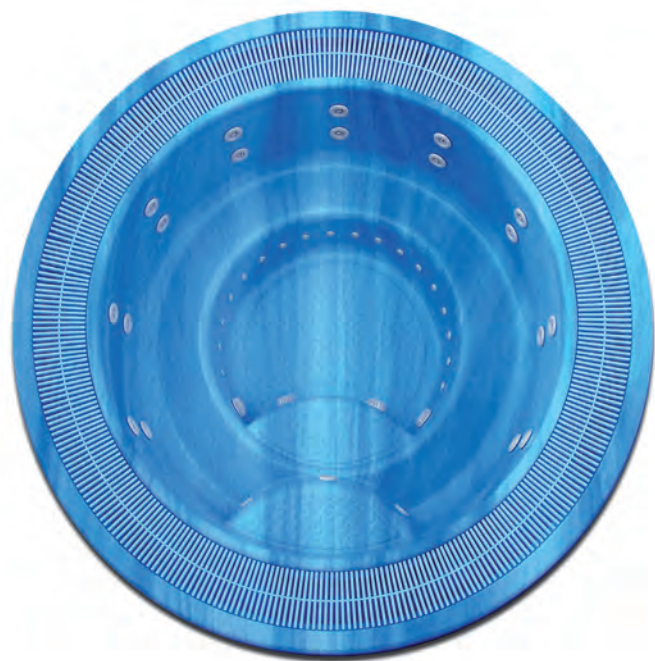

FEATURES



Dimensions: Ø 300 cm

Details: p. 380



Tokyo 70

ACRYLIC SPAS

The Tokyo 70 is a 7-user spa (6 seats + 1 loungers), designed for public or professional use. It is a spa designed to be recessed or covered. It requires filtering equipment and a compensation tank.



FEATURES



58 21 4 3

Dimensions: 340 x 240 cm
Details: p. 380

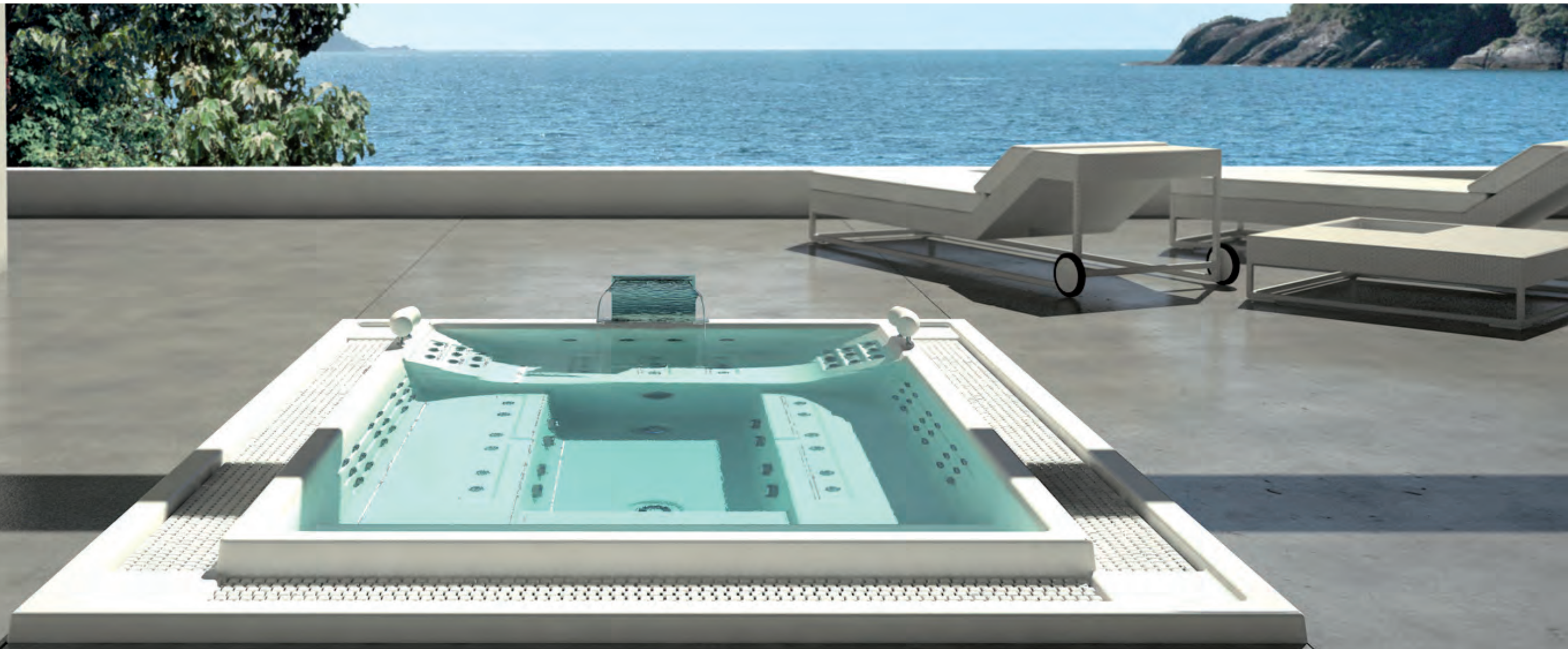

Verona

ACRYLIC SPAS

The Verona spa is a 5-user spa (3 seats + 2 loungers), designed for public or professional use.

It is a spa designed to be recessed or covered.
It requires filtering equipment and a compensation tank.



FEATURES

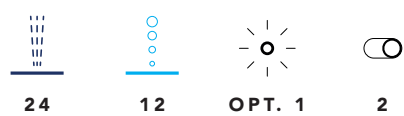

Dimensions: 228 x 228 cm

Details: p. 381

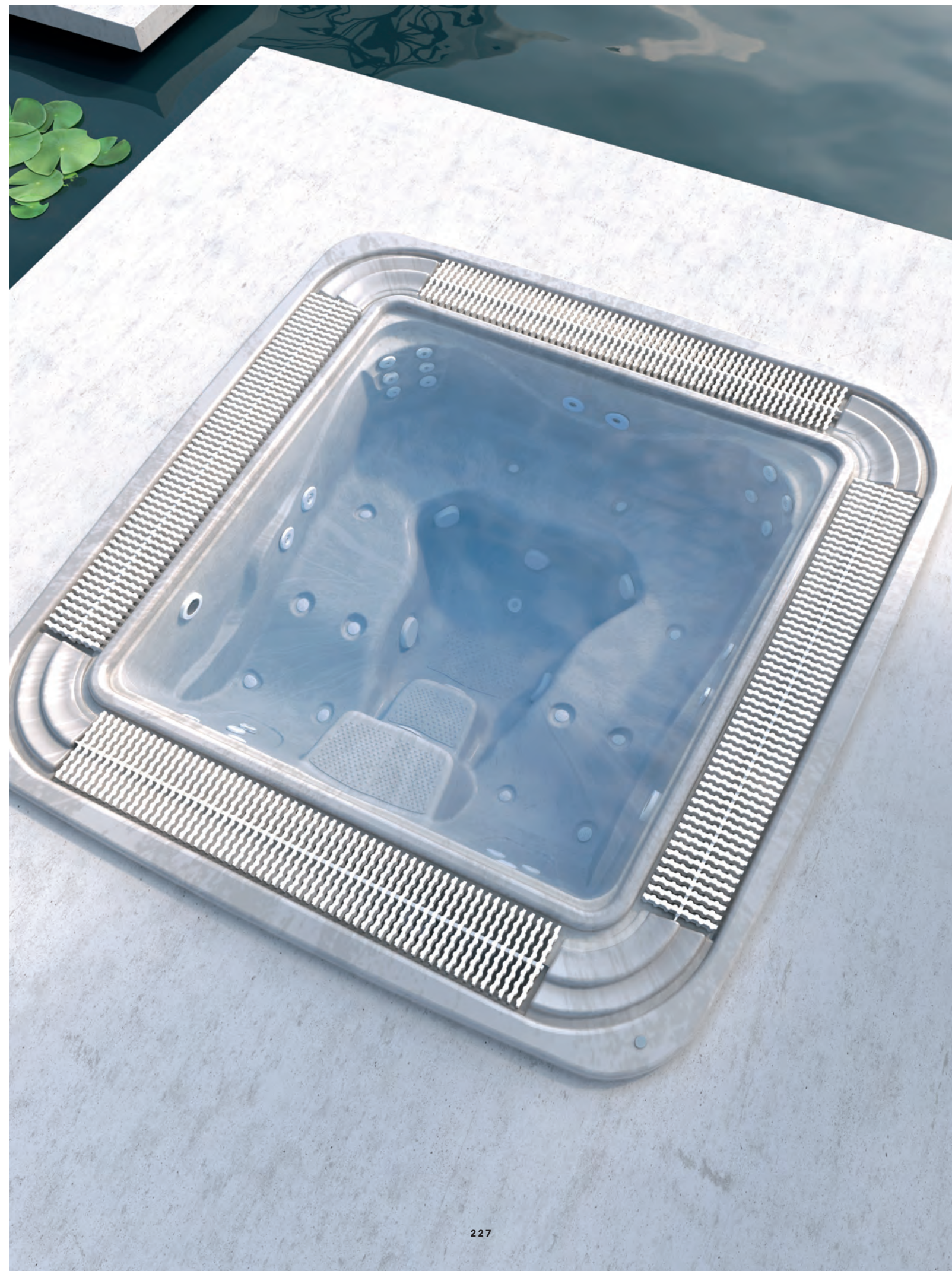



Olympia

ACRYLIC SPAS

The Olympia spa is a 11-user spa (11 seats + 0 loungers), designed for public or professional use. It is a spa designed to be recessed or covered. It requires filtering equipment and a compensation tank.



FEATURES



Dimensions: 379 x 249 cm
 Details: p. 381

Coliseum

ACRYLIC SPAS

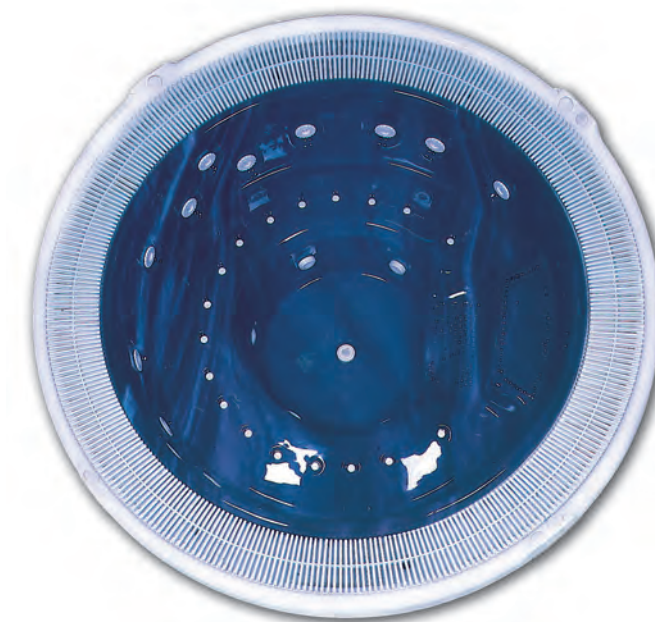

The Coliseum spa is a 10-user spa (10 seats + 0 loungers), designed for public or professional use. It is a spa designed to be recessed or covered. It requires filtering equipment and a compensation tank.

FEATURES



16 18 OPT. 1 2

Dimensions: Ø 297 cm

Details: p. 381



2.6

Nordic Baths

AstralPool's Nordic Baths in red cedar offer unique filtration technology that uses treatment to guarantee bacteria-free water. The system reduces the need for chemicals for an environmentally friendly and sustainable option. It also provides constant water renewal through an automated management system.

Wooden Bath

N O R D I C B A T H S



Diameter 150 cm - 2/3 people
 Diameter 160 cm - 3/4 people
 Diameter 180 cm - 4/5 people
 Diameter 200 cm - 6 people
 Diameter 220 cm - 9/10 people

Details: p. 382



"The finest Canadian red cedar"

Wooden Bath comes in premium, carefully selected wood. It is made from 38-mm-wide red cedar planks and has an insulated cover. A perfect option for enjoying a bath surrounded by nature.

Stainless Steel Bath

N O R D I C B A T H S

"Unique experience that blends wood and stainless steel"

Stainless Steel Bath offers high-quality finishes. It is crafted from carefully selected wood and 304 or 316L stainless steel.



Diameter 150 cm - 2/3 people
Diameter 160 cm - 3/4 people
Diameter 180 cm - 4/5 people
Diameter 200 cm - 6 people
Diameter 220 cm - 9/10 people

Details: p. 382



Chrysalis

R E L A X Z O N E

A silk cocoon enveloped his tiny feet and his entire body. He knew nothing of the coldness of the world beyond the sweet walls that protected him, but he sensed that there was something more outside his small home. He waited and waited, until he felt an inner strength, a sense that he was capable. The metamorphosis was a fact.

He saw himself, felt his body, and was overcome with the power to walk, to move forward. He was ready, prepared for this new stage of life. He carried inside him the heritage of his past, he had in him the hope of a promising tomorrow, he could almost feel the warmth of the sun against his skin. And he woke up.

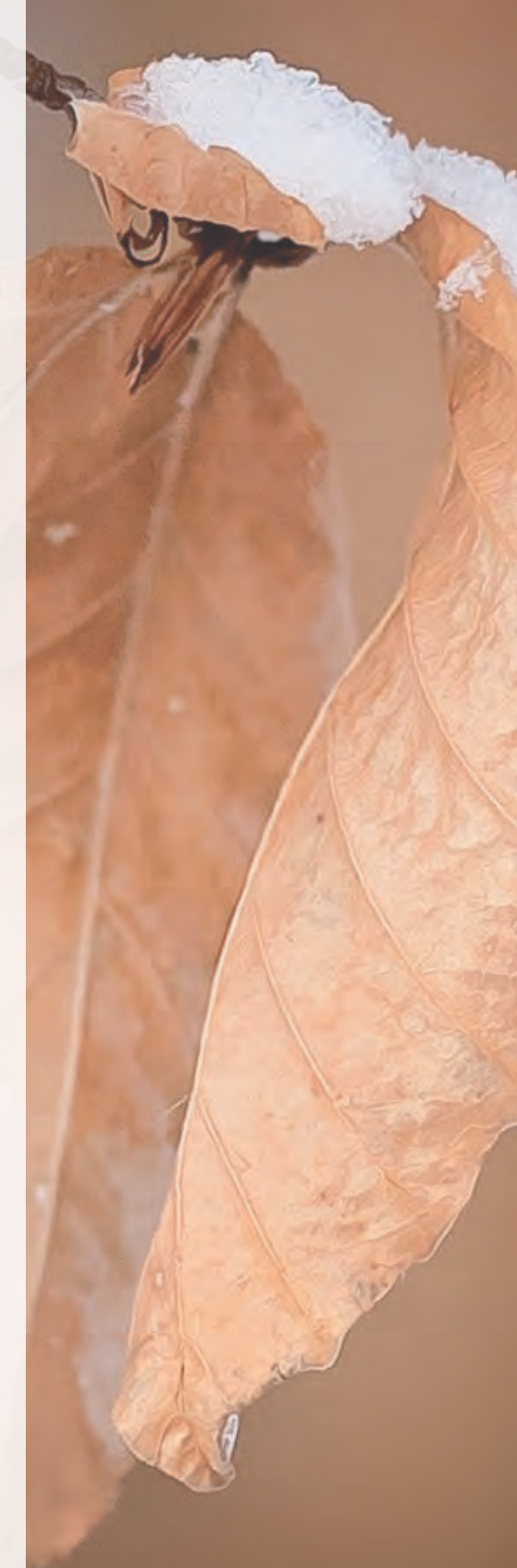



R E L A X Z O N E

3.1

Loungers

Essential for completing any temperature contrast cycle.
Take time to care not just for the body, but for the mind.
Let go of the obstacles and limits the mind creates, let
go of everything that leads to stress and unfulfillment.
Stop, look within, and blossom.



Relax Loungers to coat

Classic
Retro
Luxor
Zen

The ready-to-use loungers are crafted from a rigid foam called "EPS", a material produced from high-density beads of expanded polystyrene that provides lightweight yet long-lasting durability.

The surface of the lounge features a unique anti-slip treatment, and its design also allows for the installation of hydraulic and electric

cover systems. With both options, the surface of the lounge should be finished to provide even heat distribution and a perfect finish. Finishing the surface of the lounge in ceramic tiles is recommended (see page 325-327).

Classic

The Classic model with a Cleopatra-style base and square footrest is available in both heated (design with electric cover) and unheated solutions. This model also offers the option of straight or rounded base corners.

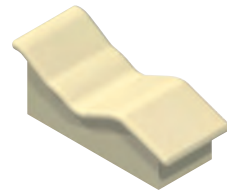

Retro

The Retro model with a Cleopatra-style base and oval footrest is available in both heated (design with electric cover) and unheated solutions.



Luxor

The Luxor model with a reclining Cleopatra-style base is designed to be installed directly on the floor. Available in both heated (design with electric cover) and unheated solutions.

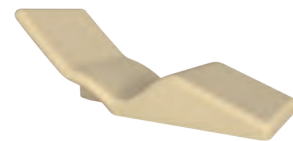

Zen

The Zen model has a disruptive and innovative design that fits all types of projects, from spaces set in the Asian wilds to new contemporary interior design. Its ergonomic and enveloping structure makes Zen a must-have element of relaxation. Available in both heated (design with electric cover) and unheated solutions.



Relax Loungers

Spacial

Aqua

Calm

Calm lounge

Elna

Vega / vega wet

AstralPool's relaxation range covers solutions for all types of projects. Intensify your relaxation with exclusively designed sun loungers crafted from premium materials to create idyllic spaces.

Spaecial

RELAX LOUNGERS



Made entirely of Scandinavian spruce and specially designed for wet areas (not recommended for outdoor use). This easily transportable lounge comes in a wide range of colors.

Details: p. 388





Aqua

RELAX LOUNGERS

Austere, fine, and elegant design. Made of premium wood, this lounge with adjustable backrest is the ideal option for casual conversations between cycles of contrast therapy.

Details: p. 388

Calm

RELAX LOUNGERS

The Calm chair for professionals is designed for long periods of continuous use. This lounge chair for toning and relaxation rooms can be manufactured with infrared lamps to relieve localized muscle tension.



Details: p. 389

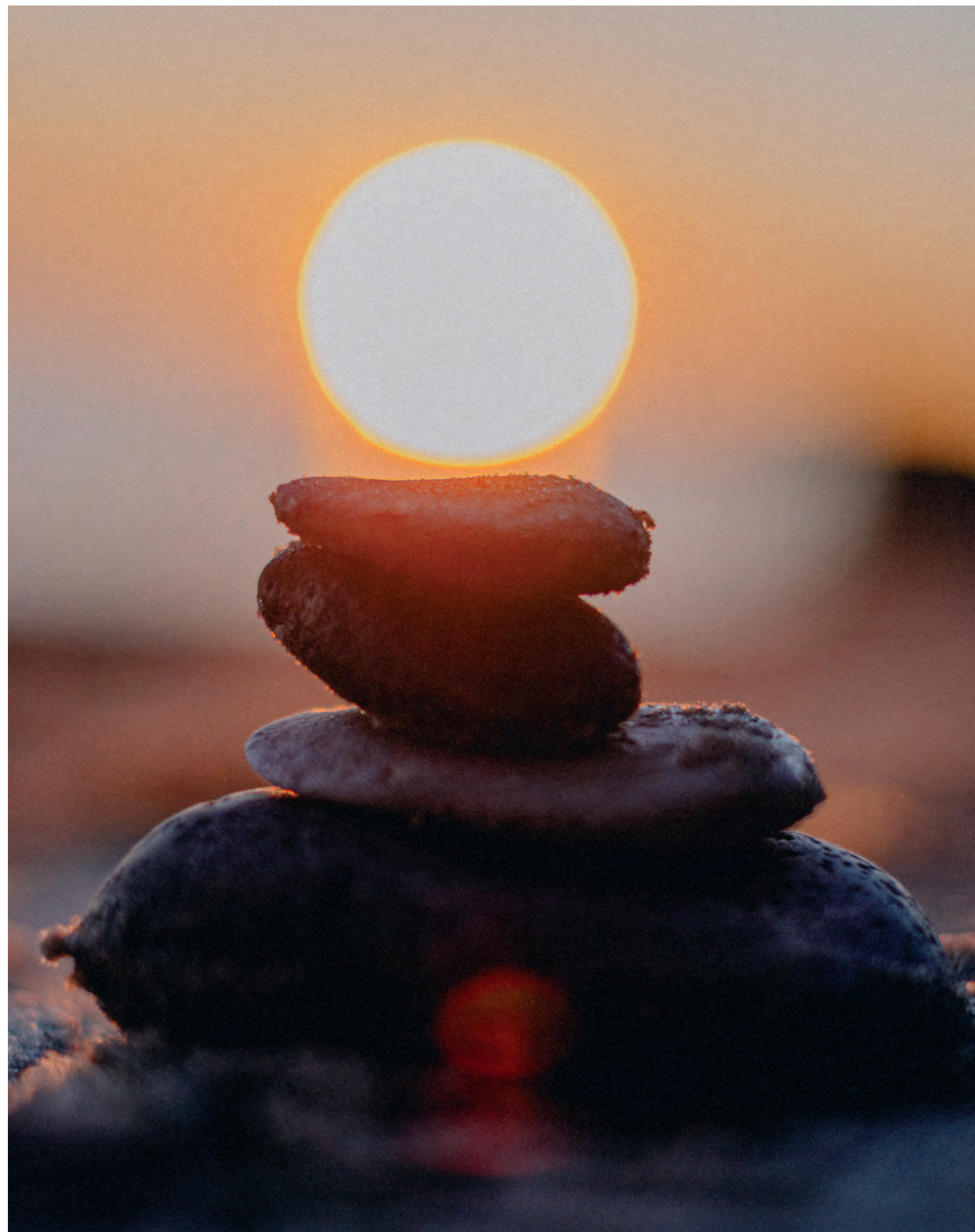

Calm Lounge

RELAX LOUNGERS

The Calm Lounge for professionals is designed for long periods of continuous use. This lounge chair for toning and relaxation rooms can be manufactured with infrared lamps to relieve localized muscle tension.

Details: p. 389





Elna

RELAX LOUNGERS

Elna is designed for professionals and long periods of continuous use. This relaxation and toning room lounge in solid surface has a temperature-controlled heating system.

Details: p. 390

Vega / Vega Wet

RELAX LOUNGERS

Stylish shapes, harmonious and ergonomic curves. Vega's wooden structure comes with standard "soft-touch" fire-resistant polyurethane upholstery. Vega Wet is the option for wet areas. It comes in a painted-metal structure and the upholstery can be optionally waterproof.



Details: p. 390

A detailed close-up photograph of a leaf's venation. The central vein is prominent, with smaller veins branching out in a pinnate pattern. The leaf surface is a deep green, and the veins are a lighter, yellowish-green color. The lighting creates a soft glow, highlighting the intricate network of veins.

Dafne

T R E A T M E N T Z O N E

The beautiful nymph chose the shelter of the tree. An imposing laurel would be her eternal home and she thanked her father for his generous gesture. She dreamed that she would see the rise of the springs and that summer would seek her precious shadow. She wouldn't have traveled without pause, without rest, without peace.

The branches of that majestic laurel would be her perpetual refuge, she would find harmony in his beautiful retreat, and there would be no storm that could wash away her idea of rising again with her spirit intact, her body in all its splendor and her mind in the throes of an epic.



T R E A T M E N T Z O N E

4.1

Treatment Showers

Hydrotherapy helps treat the most diverse illnesses, practically any ailment you can imagine, using pressure exerted on the body, simple showers or ones that use certain products, the top-down effect of jets, and localized therapy that stimulates the metabolism, nervous system, and blood flow by either holistically treating the body or with a more targeted solution using water with contrasting temperatures.

AstralPool's range of treatment showers features top-of-the-line parts. Designed for professional use, they are low-maintenance, easy to install, and equipped for long-term use.

Kneipp

TREATMENT SHOWERS

Professional contrast hydrotherapy shower featuring three separate hoses, each with its own massage nozzle for water pressure treatments controlled by a physiotherapist.



—
No Lighting
—

Dimensions: 60 x 74,8 x 17,2 cm

Details: p. 394



Vichy

TREATMENT SHOWERS

Professional contrast hydrotherapy shower featuring a fixed or adjustable arm in 316 stainless steel with 5 heads in 3 different positions: rain - massage - mist.



No Lighting

JETS

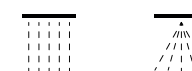

Dimensions: 42 x 42 x 21 cm

Details: p. 394

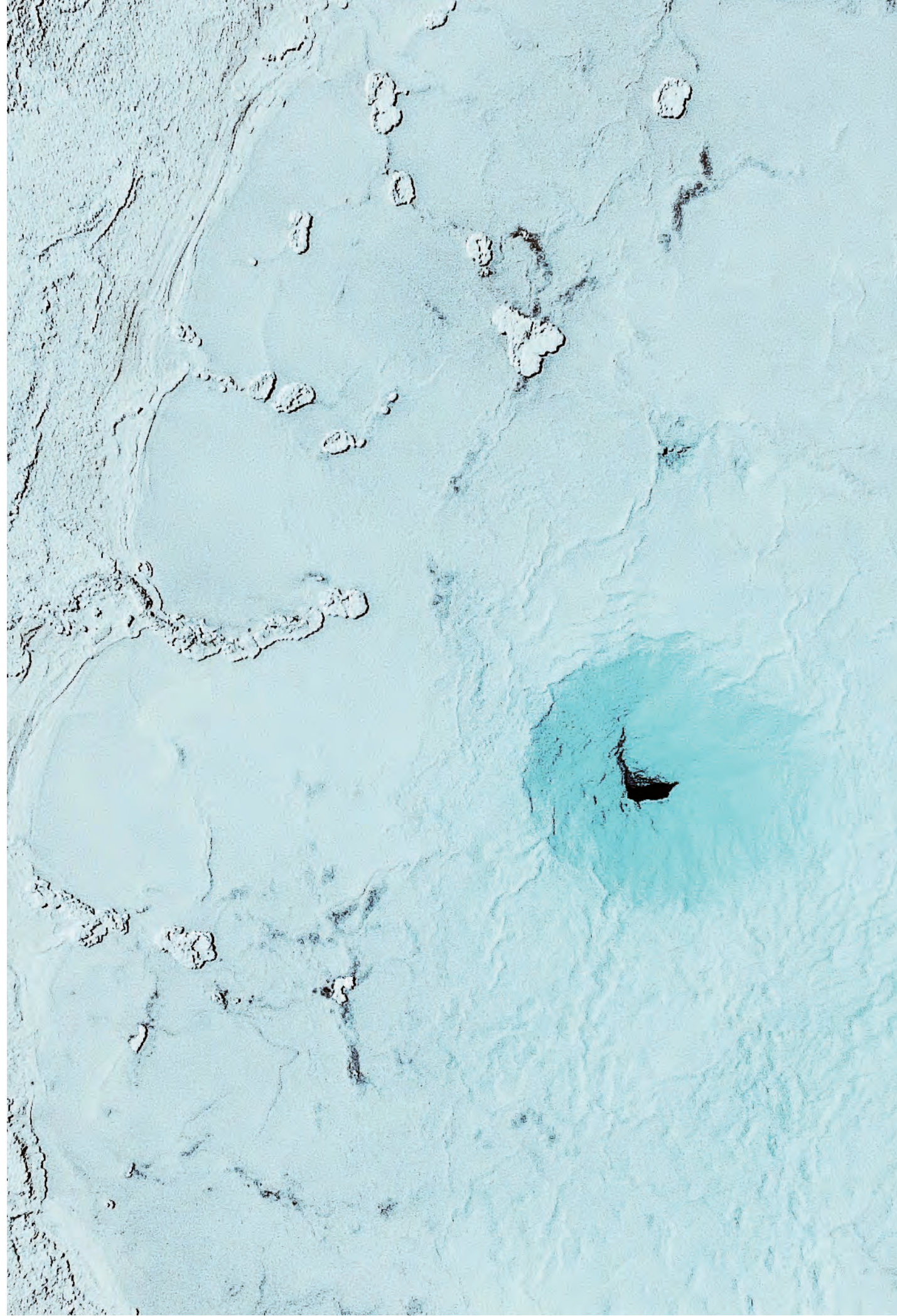

T R E A T M E N T Z O N E

4.2

Halotherapy systems

Halotherapy is a natural treatment method based on the nebulization of crystalline salt microparticles, which recreates the environmental conditions typically found in salt mines. The antibacterial and anti-inflammatory effects of these salt microparticles stimulate the immune system and help treat respiratory

diseases like asthma, bronchiolitis, cystic fibrosis, bronchitis, sinusitis, and seasonal allergies, as well as skin diseases including eczema and psoriasis. Recommended for alleviating stress, exhaustion, and sports-related injuries, it can also help unveil healthy and glowing skin.



Himalaya Cube

HALOTHERAPY SYSTEMS

Portable salt spray made from natural Himalayan salt bricks, backlit with LED light. Himalaya Cube creates unique and relaxing moods, blending elements like aroma, music, and color with halotherapy.

Dimensions (Large x width x height)(cm): 84 x 64 x 79,4

Details: p. 395

Sanama Salt Cabin

HALOTHERAPY SYSTEMS

Sanama features a modern design that fuses natural wood with elements of Himalayan salt*. Top-of-the-line finishes and outstanding details make this product a must-have for any wellness area.

Dimensions (cm): 150 x 150 x 210 / 150 x 218 x 210 /
218 x 218 x 210 / 286 x 318 x 210

— Details: p. 395

* Independent salt cabin modules.





Salt Wall

HALOTHERAPY SYSTEMS

As simple as relaxing and breathing inside a room with salt particles in the air. AstralPool's salt walls are made of blocks of Himalayan salt and built on a transparent methacrylate panel. Exceptionally easy to install and maintain. These walls include LED backlighting. Combine it with the Himalaya Cube.



Dimensions (mm): 200 x 100 x 25

Details: p. 395



T R E A T M E N T Z O N E

4.3

Portable Massage Beds

Every wellness space has to have massage tables for everything from aesthetic treatments to giving massages, whether as part of a treatment or simply to increase wellbeing. The experience of an outstanding wellness treatment depends on more than just the therapist's skill; the quality of the massage tables also play a major role in delivering an intense sensory experience.

Many treatments require a massage table: thermal mud massages, ayurvedic massages, toning or energizing massages, salt baths, wraps, and hot stones all use massage tables or automated treatment tables.

AstralPool's range of portable massage tables are a robust and stylish option that adds complete flexibility when it comes to your session locations.

Confortflex

PORTABLE MESSAGE BEDS



Dimensions (cm): 68 x 185 x 66/81



Details: p. 396



Ideal either as a stationary couch in a clinic or a sturdy portable, the Confortflex has all

the features of spa couches while offering the benefits of being portable.

Deluxe

PORTABLE MESSAGE BEDS

The Deluxe features luxurious Affinity Therafoam comfort padding, soft touch PU upholstery and ergonomic design, thus reaching exceptional levels in both client and therapist comfort.



Dimensions (cm): 68 x 185 x 66/81



Details: p. 396



Dimensions (cm): 63/71,2 x 185 x 62/82,5

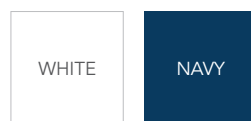

Details: p. 397



Marlin

PORTABLE MESSAGE BEDS

Marlin has been designed to be used and taken to the next appointment with the minimum of strain and difficulty for the therapist.. A slimline but strong table featuring a 4 leg cable system making it ideal for sports massage and mobile beauty treatments.

4.4.1. Earth
4.4.2. Genuine
4.4.3. Well
4.4.4. Sense
4.4.5. Lake
4.4.6. Sphere
4.4.7. Apolo
4.4.8. Aqua
4.4.9. Venus / Himalaya salt
4.4.10. Ocean
4.4.11. Ayurvedic
4.4.12. Natura



T R E A T M E N T Z O N E

4.4

Spa Tables

Our range of stationary massage tables adapts to each customer's needs and aesthetics, from the sleekest to the most glamorous or ethnic design.

Our aim is to create innovative designs with high-tech elements to ensure flawless ergonomics and comfort for both the professional and the user.

This collection opens the door to unique multi-sensory experiences designed to incorporate color, smell, music, even touch (warm water bed).

Earth

SPA TABLES



Dimensions (cm): 73 x 189 x 75

SKAY

WOOD

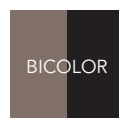

Details: p. 398



Multifunctional table ideal for facial, body, and massage treatments. Available in two wood colors for the structure. Soft touch, fireproof, and oil resistant PU upholstery. Stationary height. Manually adjustable backrest. Lower shelf for storage.



Genuine

SPA TABLES

Multifunctional bed with a single motor, ideal for facial, body and massage treatments. Metal structure finished in white wood. Soft touch, fireproof, and oil resistant PU upholstery. Electrically adjustable height. Manually adjustable backrest. Lower base/shelf for storage.



Dimensions (cm): 76 x 188 x 56/76

SKAY



WHITE



BEIGE

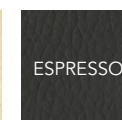

ESPRESSO

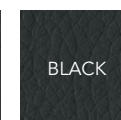

BLACK

WOOD



WHITE

skay option on request

Details: p. 398

Well

SPA TABLES



Dimensions (cm): 75 x 202 x 64/84

WOOD

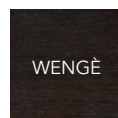

Details: p. 398



Table with four motors and a metal structure finished in white or wenge wood . Perfect for face and body massage treatments.

Electrically adjustable height, backrest, and legs. Soft touch and fireproof PU upholstery. Oil resistant base/shelf for accessories.



Sense

SPA TABLES

Multi-function table with four motors for face and body massage treatments.

Electrically adjustable height, backrest, and legs.

Adjustable armrests with gas pump.

Soft touch, fireproof, and oil resistant PU upholstery.

LED lighting around the base.



Dimensions (cm): 78,5 x 189 x 54/74

Details: p. 398



Dimensions (cm): 76 x 202 x 62/82
76 x 186 x 62/82 (optional)

WOOD



Details: p. 398



Lake

SPA TABLES

Table with four motors and a metal structure finished in white or wenge wood. Perfect for face and body massage treatments.

Electrically adjustable height, backrest, and legs.

Soft touch, fireproof, and oil resistant white PU upholstery.

Lower shelf for storage.

Sphere

SPA TABLES

Multi-function table with 4 motors for treatments and massages.
 Metal structure finished in curved wood.
 Electrically adjustable height, backrest, and leg rest.
 Lower accessory compartment with drawer.



Dimensions (cm): 82 x 200 x 65/90

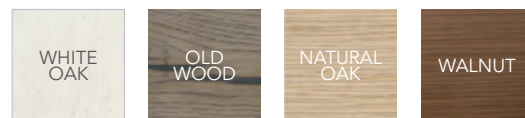

Details: p. 398





Apolo

SPA TABLES

Multi-function treatment table with 4 motors.
 Adjustable height (from 62 - 82 cm).
 Armrests with adjustable height with gas pump.
 Mattress size: 80 cm x 192 cm x 15 cm (19 cm mattress optional);
 MULTI-SOFT, PU-SOFT TOUCH comfort upholstery
 Finishes: wenge, gray (optional).
 Sliding Plexiglas panels, shockproof.
 (wood panels optional)
 Includes accessory compartment with LED lighting.

Dimensions (cm): 78,5 x 189 x 62/82



Details: p. 398

Aqua

SPA TABLES



Dimensions (cm): 92 x 219 x 61/81

Details: p. 398



Multi-function table for classic treatments (with mattress) and for spa treatments (warm + wet) on a Corian surface. White metal structure. Folding mattresses

(storage compartment). Aromatherapy. Telescopic shower. It includes hospital-style and easily disinfected Corian trays.

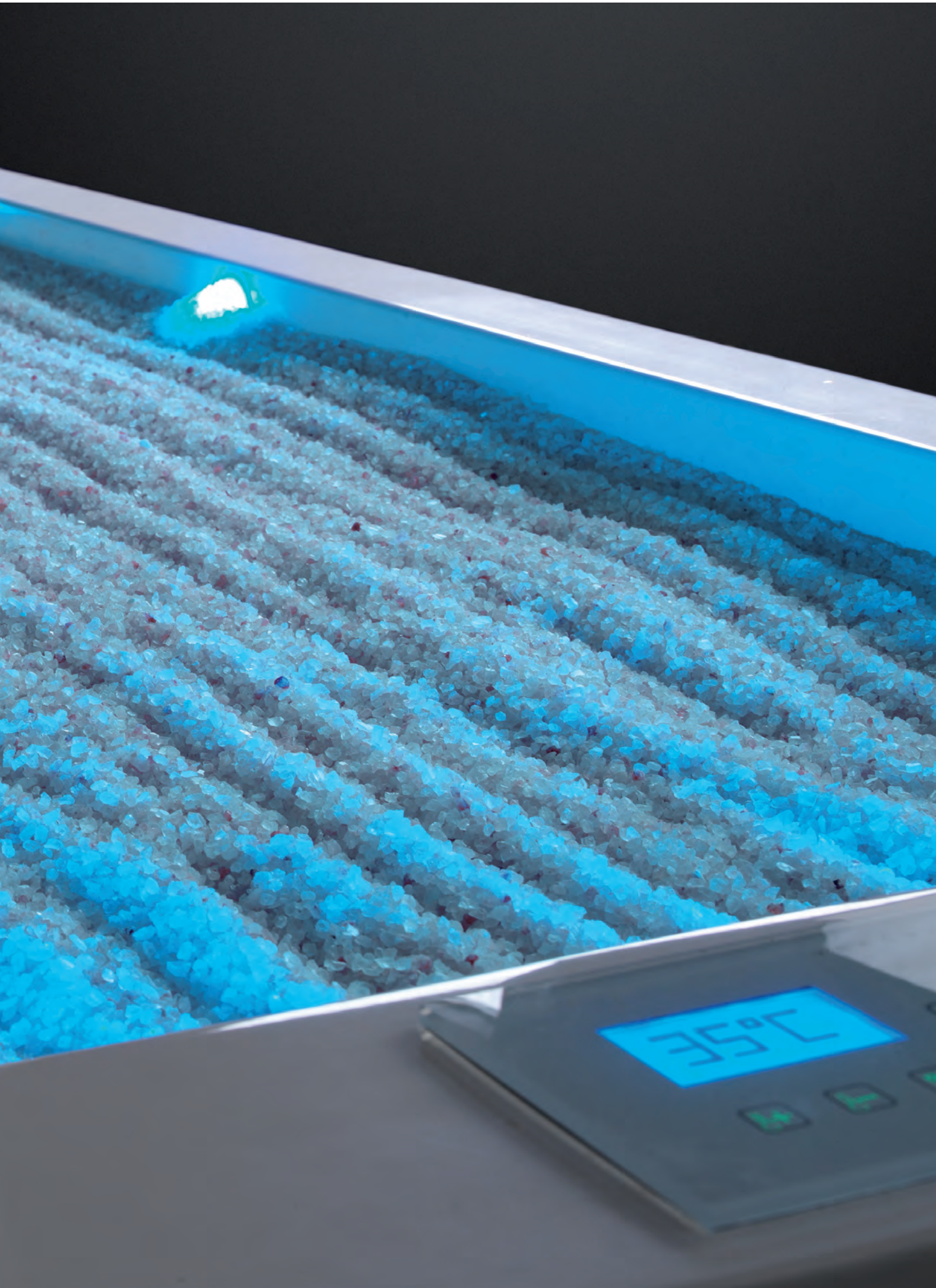

Venus / Himalaya Salt

SPA TABLES

Table with a metal structure covered in white or wenge wood, perfect for wellness and relaxation treatments.

Adjustable height (from 54 - 84 cm) with motor (24 volts).

The heated base (at 48 volts) can hold:

- Himalayan salt (HIMALAYA SALT)
- Water mattress (VENUS)

Includes LED-RGB lighting + digital touch control panel.

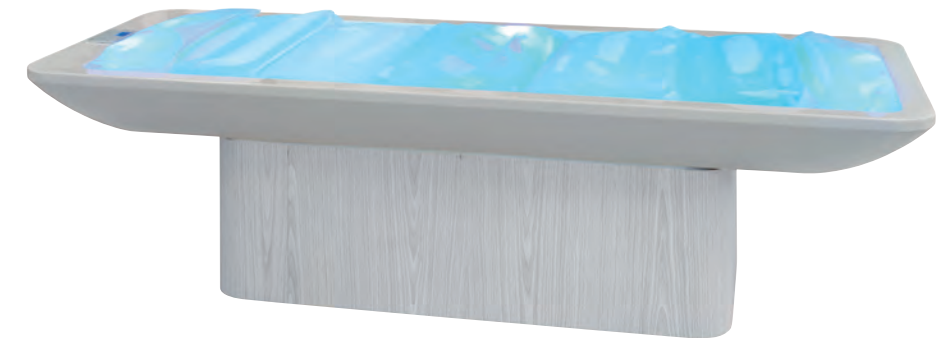

Dimensions (cm): 92 x 219 x 58/84



Details: p. 398



Dimensions (cm): 74 x 200 x 57/88



Details: p. 398



Ocean

SPA TABLES

3-motor table with metal structure finished in white or oak wood.

Extra-long armrests and finger relaxation: adjustable with gas pump.

Electrically adjustable height, backrest, and leg rest. Soft touch and fireproof PU upholstery.

Oil resistant.



In collaboration with renowned Indian experts, AstralPool offers a special range of equipment dedicated to Ayurvedic massage, an increasingly common treatment in wellness centers following the developments of traditional Indian medicine over the millennium.

The massage tables, two types of Shirodara and a full series of accessories and furniture reflect, with utmost precision, the dictates of the authentic Indian ayurvedic tradition.

Ayurvedic

SPA TABLES



Dimensions (cm): 85 x 186 x 68/83

ESPRESSO

Details: p. 398

Natura

SPA TABLES

Natura recreates the fascinating atmosphere of Bali's spas, integrating original elements into western-style wellness. This massage table is crafted from Balinese teak wood to create an iconic and elegant product in any natural space.



Dimensions (cm): 81 x 202 x 70



Details: p. 398



T R E A T M E N T Z O N E

4.5

Moodify

The new Fluidra product that crosses the barriers of the current wellness concept.

Moodify is the first emotional manager on the market capable of adapting to user needs in order to offer the perfect experience.

This disruptive product fuses different treatment concepts in just one session that will stimulate all your senses without the need for a therapist, only using the latest technology.

PILLARS



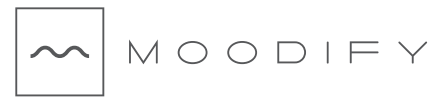

CHANGE YOUR
MOOD



Get unique Moodify experiences. Create a wellness 2.0 space by incorporating the version that best fits your project.

Moodify Room

THE MINIMAL PROPOSAL

Basic Moodify creates an interactive room with a Moodify vehicle that connects to several devices that stimulate the senses. Vehicle: La Playa Laghetto. Devices: Audio / Projection / Bubbles / Temperature / Aroma / Lighting.

Moodify Ambient

THE MODULAR PROPOSAL

Moodify Ambient can be customized to fit the needs of both new projects and existing facilities. Not only does it provide the essence of Moodify Room to the space, it also has the added bonus of serving as a room environment manager, making it possible to create different moods in a single space.

Moodify Spa

THE LUXE EXPERIENCE

Moodify SPA, the 2.0 version of Moodify Ambient. This new version delivers the services of the earlier version with the addition of a key feature: Communication between vehicles. Moodify SPA offers a complete, guided treatment experience through the connected vehicles.

*Vehicle: Element incorporated into the wellness space (sauna, steam room, pool, etc.) where the Moodify experience is enjoyed



Technical Characteristics

Phoenix

TEMPERATURE ZONE



Saunas

TEMPERATURE ZONE

CLASSIC SELECT

| CODE | DIMENSIONS | POWER (kW) | SAUNA PANELS | | | | | | |
|-------|-------------|-------------------|-----------------|---------------|------------|-------------------------|-----------|----------|------------|
| | | | Hemlock Plywood | Nordic Spruce | White Pine | Thermo Aspen/Alder/Pine | Red Cedar | Magnolia | Bench wood |
| 70431 | 150x150x210 | 4,5kW 230/400 3~ | N/A | Standard | Optional | Optional | Optional | N/A | Abachi |
| 70432 | 200x150x210 | 6kW 230/400 3~ | | | | | | | |
| 70433 | 200x200x210 | 6kW 230/400 3~ | | | | | | | |
| 70455 | 250x200x210 | 8kW 230/400 3~ | | | | | | | |
| 70434 | 250x250x210 | 9kW 230/400 3~ | | | | | | | |
| 70436 | 300x250x210 | 10,5kW 230/400 3~ | | | | | | | |
| 70437 | 300x300x210 | 13,5kW 230/400 3~ | | | | | | | |
| 70438 | 400x300x210 | 16,5kW 230/400 3~ | | | | | | | |

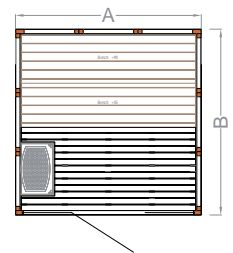
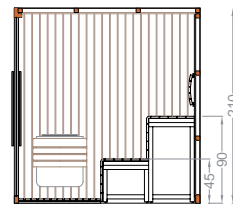

BORRO

| CODE | DIMENSIONS | POWER (kW) | SAUNA PANELS | | | | | | |
|-------|-------------|-------------------|-----------------|---------------|------------|-------------------------|-----------|----------|-------------|
| | | | Hemlock Plywood | Nordic Spruce | White Pine | Thermo Aspen/Alder/Pine | Red Cedar | Magnolia | Bench wood |
| 72920 | 200x200x210 | 6kW 230/400 3~ | N/A | Optional | Optional | Standard | Optional | N/A | Thermo Pine |
| 72921 | 250x200x210 | 8kW 230/400 3~ | | | | | | | |
| 72922 | 250x250x210 | 9kW 230/400 3~ | | | | | | | |
| 72923 | 300x250x210 | 10,5kW 230/400 3~ | | | | | | | |
| 72924 | 300x300x210 | 13,5kW 230/400 3~ | | | | | | | |
| UR* | 400x300x210 | 16,5kW 230/400 3~ | | | | | | | |

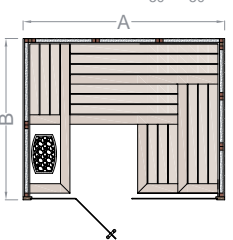
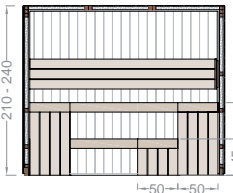

MIRAMONTE

| CODE | DIMENSIONS | POWER (kW) | SAUNA PANELS | | | | | | |
|-------|-------------|---------------------|-----------------|---------------|------------|-------------------------|-----------|----------|------------|
| | | | Hemlock Plywood | Nordic Spruce | White Pine | Thermo Aspen/Alder/Pine | Red Cedar | Magnolia | Bench wood |
| 70470 | 200x150x210 | 7 kW 230/400V 3~ | N/A | Optional | Standard | Optional | Optional | N/A | Abachi |
| 70471 | 200x200x210 | 7 kW 230/400V 3~ | | | | | | | |
| 70439 | 250x200x210 | 9 kW 230/400V 3~ | | | | | | | |
| 70440 | 250x250x210 | 9 kW 230/400V 3~ | | | | | | | |
| 70441 | 300x250x210 | 10,8 kW 230/400V 3~ | | | | | | | |
| 70442 | 300x300x210 | 13,5 kW 230/400V 3~ | | | | | | | |

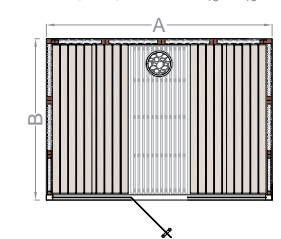

FIORA

| CODE | DIMENSIONS | POWER (kW) | SAUNA PANELS | | | | | | |
|------|-------------|----------------|-----------------|---------------|------------|-------------------------|-----------|----------|------------|
| | | | Hemlock Plywood | Nordic Spruce | White Pine | Thermo Aspen/Alder/Pine | Red Cedar | Magnolia | Bench wood |
| UR* | 180x180x210 | 6kW 230/400 3~ | N/A | N/A | N/A | Standard | N/A | N/A | Abachi |
| UR* | 200x200x210 | 6kW 230/400 3~ | | | | | | | |
| UR* | 250x200x210 | 8kW 230/400 3~ | | | | | | | |
| UR* | 250x250x210 | 9kW 230/400 3~ | | | | | | | |

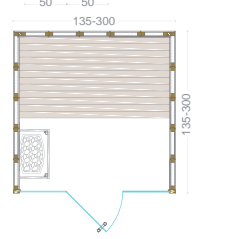
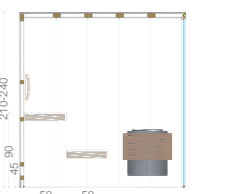

NERA

| CODE | DIMENSIONS | POWER (kW) | SAUNA PANELS | | | | | | |
|------|-------------|-------------------|-----------------|--------------------------|------------|-------------------------|-----------|----------|------------|
| | | | Hemlock Plywood | Nordic Spruce | White Pine | Thermo Aspen/Alder/Pine | Red Cedar | Magnolia | Bench wood |
| UR* | 180x180x210 | 7kW 230/400 3~ | N/A | Standard (black painted) | N/A | N/A | N/A | N/A | Abachi |
| UR* | 200x200x210 | 7kW 230/400 3~ | | | | | | | |
| UR* | 250x200x210 | 7kW 230/400 3~ | | | | | | | |
| UR* | 250x250x210 | 10,8kW 230/400 3~ | | | | | | | |

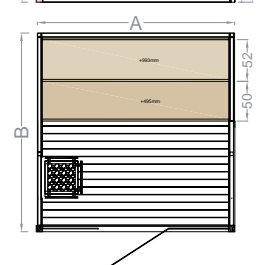
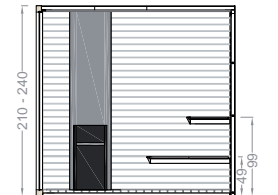

ST. MORITZ

| CODE | DIMENSIONS | POWER (kW) | SAUNA PANELS | | | | | | |
|-------|-------------|-------------------|-----------------|---------------|------------|-------------------------|-----------|----------|------------|
| | | | Hemlock Plywood | Nordic Spruce | White Pine | Thermo Aspen/Alder/Pine | Red Cedar | Magnolia | Bench wood |
| 72907 | 135x135x210 | 4,5kW 230V 1~ | Standard | N/A | N/A | N/A | N/A | N/A | Abachi |
| 72908 | 180x180x210 | 6kW 230/400 3~ | | | | | | | |
| 72909 | 220x220x210 | 8kW 230/400 3~ | | | | | | | |
| 72910 | 260x220x210 | 9kW 230/400 3~ | | | | | | | |
| 72911 | 300x250x210 | 10,5kW 230/400 3~ | | | | | | | |
| 72912 | 300x300x210 | 13,5kW 230/400 3~ | | | | | | | |

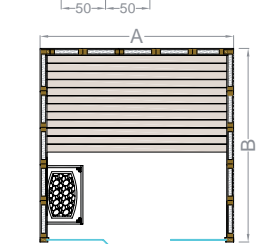
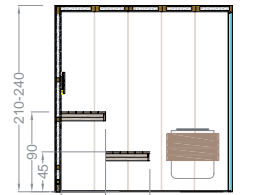

INNSBRUCK

| CODE | DIMENSIONS | POWER (kW) | SAUNA PANELS | | | | | | |
|-------|-------------|-------------------|-----------------|---------------|------------|-------------------------|-----------|----------|------------|
| | | | Hemlock Plywood | Nordic Spruce | White Pine | Thermo Aspen/Alder/Pine | Red Cedar | Magnolia | Bench wood |
| 72901 | 135x135x210 | 4,5kW 230V 1~ | Standard | N/A | N/A | N/A | N/A | N/A | Abachi |
| 72902 | 180x180x210 | 6kW 230/400 3~ | | | | | | | |
| 72903 | 220x220x210 | 8kW 230/400 3~ | | | | | | | |
| 72904 | 260x220x210 | 9kW 230/400 3~ | | | | | | | |
| 72905 | 300x250x210 | 10,5kW 230/400 3~ | | | | | | | |
| 72906 | 300x300x210 | 13,5kW 230/400 3~ | | | | | | | |

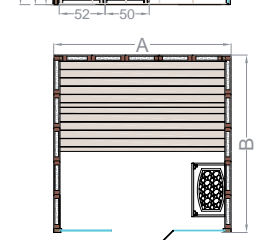
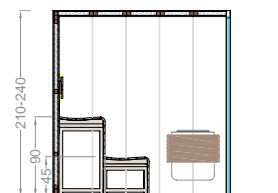

LOBOS

| CODE | DIMENSIONS | POWER (kW) | SAUNA PANELS | | | | | | |
|-------|-------------|----------------|-----------------|---------------|------------|-------------------------|-----------|----------|------------|
| | | | Hemlock Plywood | Nordic Spruce | White Pine | Thermo Aspen/Alder/Pine | Red Cedar | Magnolia | Bench wood |
| 72913 | 134x254x210 | 7kW 230/400 3~ | Standard | N/A | N/A | N/A | N/A | N/A | Abachi |
| 72914 | 194x194x210 | 7kW 230/400 3~ | | | | | | | |
| 72915 | 254x254x210 | 9kW 230/400 3~ | | | | | | | |

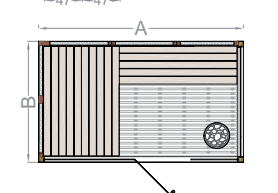
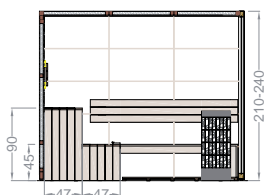

* under request

Saunas

TEMPERATURE ZONE

BELLA

| CODE | DIMENSIONS | POWER (kW) | SAUNA PANELS | | | | | | |
|-------|-------------|-----------------|-----------------|---------------|------------|-------------------------|-----------|----------|--------------|
| | | | Hemlock Plywood | Nordic Spruce | White Pine | Thermo Aspen/Alder/Pine | Red Cedar | Magnolia | Bench wood |
| 72916 | 180x180x210 | 7kW 230/400 3~ | Standard | N/A | N/A | N/A | N/A | N/A | Thermo Aspen |
| 72917 | 230x180x210 | 7kW 230/400 3~ | | | | | | | |
| 72918 | 230x230x210 | 11kW 230/400 3~ | | | | | | | |
| 72919 | 280x230x210 | 11kW 230/400 3~ | | | | | | | |

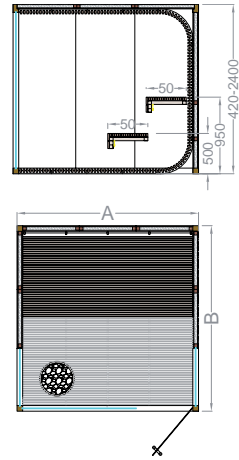

HONEY

| CODE | DIMENSIONS | POWER (kW) | SAUNA PANELS | | | | | | |
|-------|-------------|---------------------|-----------------|---------------|------------|-------------------------|-----------|----------|--------------|
| | | | Hemlock Plywood | Nordic Spruce | White Pine | Thermo Aspen/Alder/Pine | Red Cedar | Magnolia | Bench wood |
| 72896 | 180x180x212 | 7 kW 230/400V 3~ | Standard | N/A | N/A | N/A | N/A | N/A | Thermo Aspen |
| 72897 | 233x180x212 | 9 kW 230/400V 3~ | | | | | | | |
| 72898 | 233x233x212 | 9 kW 230/400V 3~ | | | | | | | |
| 72899 | 285x233x212 | 10,8 kW 230/400V 3~ | | | | | | | |
| 72900 | 285x285x212 | 13,5 kW 230/400V 3~ | | | | | | | |

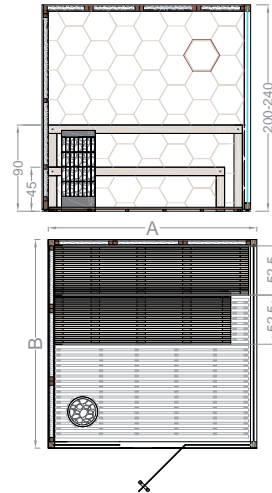

ESSENTIA

| CODE | DIMENSIONS | POWER (kW) | SAUNA PANELS | | | | | | |
|-------|-------------|-------------------|-----------------|---------------|------------|-------------------------|-----------|----------|-----------------|
| | | | Hemlock Plywood | Nordic Spruce | White Pine | Thermo Aspen/Alder/Pine | Red Cedar | Magnolia | Bench wood |
| 72892 | 200x200x225 | 7kW 230/400 3~ | N/A | N/A | N/A | Optional | N/A | Standard | Thermo Magnolia |
| 72893 | 250x200x225 | 7kW 230/400 3~ | | | | | | | |
| 72894 | 250x250x225 | 10.8kW 230/400 3~ | | | | | | | |
| 72895 | 300x250x225 | 10,8kW 230/400 3~ | | | | | | | |

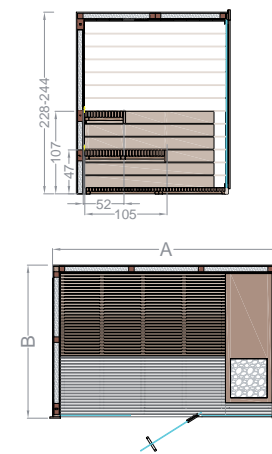

OUTDOOR

On request

Accessories

| CODE | ACCESSORIES | MEASURE | CLASSIC | MIRAMONTE | INNSBRUCK | ST. MORITZ | LOBOS | BELLA | HONEY | BORRO | NERA | FIORA | ESSENTIA |
|---------|---|---------|----------|-----------|-----------|------------|----------|----------|----------|----------|----------|----------|----------|
| 70443 | Stainless steel sauna accessories set | un. | Optional | Optional | Optional | Optional | Optional | Optional | Optional | Optional | Optional | Optional | Optional |
| 70444 | Salt decorative elements set | un. | Optional | Optional | Optional | Optional | Optional | N/A | N/A | N/A | N/A | N/A | Optional |
| 70445 | RGB Led lighting kit with remote control | un. | Optional | Optional | Optional | Optional | Optional | Optional | Optional | Optional | Optional | Optional | Optional |
| 70446 | Touchscreen control unit for sauna heater | un. | Optional | Standard | Standard | Standard | Standard | Standard | Standard | Standard | Standard | Standard | Standard |
| 70447 | Outside wall finished with vertical timber panels | lin.m. | Optional | Optional | Optional | Optional | Optional | Optional | Optional | Optional | Optional | Optional | Optional |
| 70448 | Roof extension | sq.m. | Optional | Optional | Optional | Optional | Optional | Optional | Optional | Optional | Optional | Optional | Optional |
| 70449 | Tintes/ transparent glass window | sq.m. | Optional | Optional | Optional | Optional | Optional | Optional | Optional | Optional | Optional | Optional | Optional |
| 70450 | Concealed heater for sauna up to 300x250cm | un. | Optional | Optional | Optional | Optional | Optional | N/A | N/A | Optional | N/A | N/A | N/A |
| 70451 | Concealed heater for sauna more than 300x250cm | un. | Optional | Optional | Optional | Optional | Optional | N/A | N/A | Optional | N/A | N/A | N/A |
| 70452 | Additional wall for hidden water | lin.m. | Optional | Optional | Optional | Optional | Optional | N/A | N/A | Optional | N/A | N/A | N/A |
| 70453 | Aroma design system | un. | Optional | Optional | Optional | Optional | Optional | Optional | Optional | Optional | Optional | Optional | Optional |
| 70456 | Decorative wall protection made of stones | un. | Optional | Optional | Optional | Optional | Optional | N/A | N/A | N/A | Optional | Optional | N/A |
| 70457 | RGB Chromo therapy kit with remote control | un. | Optional | Optional | Optional | Optional | Optional | N/A | Optional | Optional | Optional | Optional | Optional |
| Request | 2nd full glass side | sq.m. | N/A | N/A | N/A | N/A | Optional | Optional | Optional | N/A | N/A | N/A | N/A |
| Request | Glass roof panel | sq.m. | Optional | Optional | Optional | Optional | Optional | Optional | Optional | Optional | N/A | N/A | N/A |
| Request | Heater safety railing | un. | Standard | Optional | Standard | Standard | Standard | Optional | Standard | N/A | N/A | Standard | N/A |

Steam Baths

TEMPERATURE ZONE

ASANA

| CODE | 73908 | 73909 | 73910 | 73911 | 73912 |
|----------------------|---|-------------|-------------|-------------|-------------|
| Dimensions A-B (cm) | 200x200x220 | 250x200x220 | 250x250x220 | 300x250x220 | 300x300x220 |
| Power | 9 kW | 9 kW | 9 kW | 12 kW | 12 kW |
| Control | Ecotouch | | | | |
| Wall finish | Kelya Porcelain (2) | | | | |
| Becnh finish | Sirius Porcelain (1) | | | | |
| Accessories finish | Black Matte | | | | |
| Ceiling | Black methacrylate | | | | |
| Lighting | Warm white perimeter LED on ceiling and under benches | | | | |
| Included accessories | 2 puff | | | | |

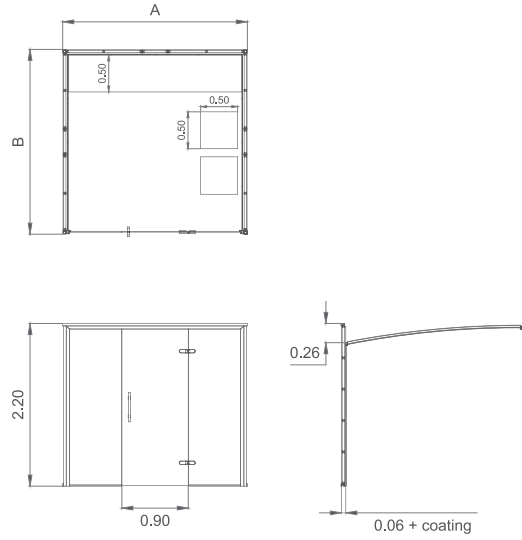

BANDHA

| CODE | 73921 | 73922 | 73923 | 73924 |
|----------------------|---|-------------|-------------|-------------|
| Dimensions A-B (cm) | 250x200x220 | 250x250x220 | 300x250x220 | 300x300x220 |
| Power | 9 kW | 9 kW | 12 kW | 12 kW |
| Control | Ecotouch | | | |
| Wall finish | Gada Porcelain (0) | | | |
| Becnh finish | Gada Porcelain (0) | | | |
| Accessories finish | Stainless steel | | | |
| Ceiling | White methacrylate | | | |
| Lighting | Warm white perimeter LED on ceiling and under benches | | | |
| Included accessories | 2 puffs + 1 porcelain sink | | | |

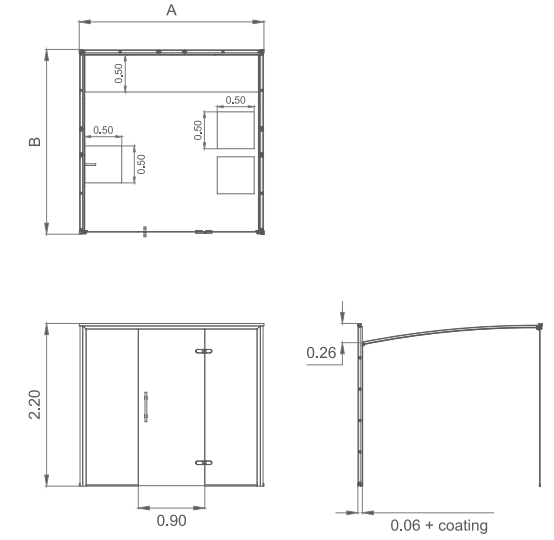

CALA

| CODE | 73913 | 73914 | 73915 | 73916 |
|----------------------|---|-------------|-------------|-------------|
| Dimensions A-B (cm) | 250x200x220 | 250x250x220 | 300x250x220 | 300x300x220 |
| Power | 9 kW | 9 kW | 12 kW | 12 kW |
| Control | Ecotouch | | | |
| Wall finish | Kreta Porcelain (2) + Sirius (1) | | | |
| Becnh finish | Kreta Porcelain (2) | | | |
| Accessories finish | Stainless steel | | | |
| Ceiling | Black methacrylate | | | |
| Lighting | Starry sky + Warm white perimeter LED under bench | | | |
| Included accessories | Porcelain Sink | | | |

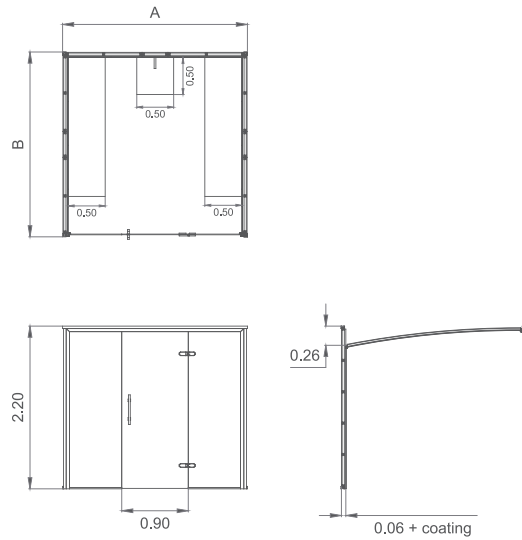

HARA

| CODE | 73925 | 73926 | 73927 |
|----------------------|---|-------------|-------------|
| Dimensions A-B (cm) | 250x250x220 | 300x250x220 | 300x300x220 |
| Power | 9 kW | 12 kW | 12 kW |
| Control | Ecotouch | | |
| Wall finish | Radium Porcelain (2) | | |
| Becnh finish | Nilium Porcelain (2) | | |
| Accessories finish | Black Matte | | |
| Ceiling | Black methacrylate | | |
| Lighting | Starry sky + Warm white perimeter LED under bench | | |
| Included accessories | 1 puff | | |

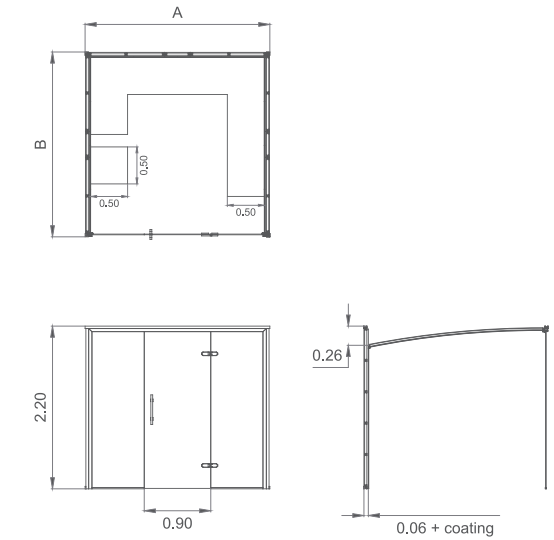

SUTRA

| CODE | 73917 | 73918 | 73919 | 73920 |
|----------------------|---|-------------|-------------|-------------|
| Dimensions A-B (cm) | 250x200x220 | 250x250x220 | 300x250x220 | 300x300x220 |
| Power | 9 kW | 9 kW | 12 kW | 12 kW |
| Control | Ecotouch | | | |
| Wall finish | White solid surface | | | |
| Becnh finish | Kairos Porcelain (3) | | | |
| Accessories finish | Black Matte | | | |
| Ceiling | White methacrylate | | | |
| Lighting | Warm white perimeter LED on ceiling and under benches | | | |
| Included accessories | - | | | |

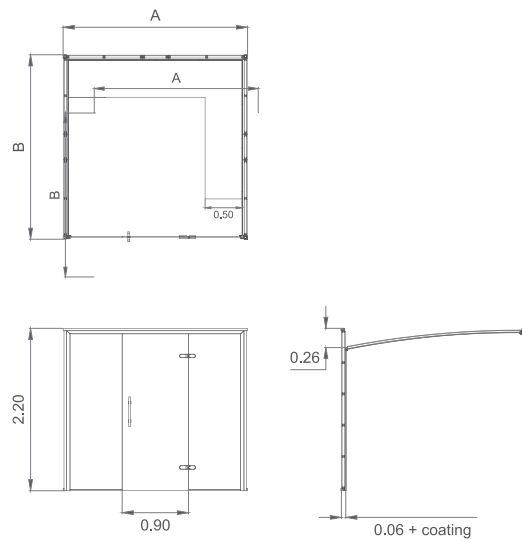

Create your customizable steam room option:

TEMPERATURE ZONE

CUSTOMIZABLE CODE

| DIGITS | 12345 | - | 6 | 7-8 | 9-10 | 11 | 12 | 13 | 14 |
|--------|-----------|---|----------------|----------------|---------------|---------|---------|------------|------------|
| | BASE CODE | | BENCH SETTINGS | BENCH FINISHES | WALL FINISHES | FRAMING | CEILING | Optional 1 | Optional 2 |

CUSTOMIZABLE CODE EXAMPLE

| DIGITS | 74026 | - | C | 3F | SS | B | 5 | - | - |
|--------|-----------|---|----------------|----------------|---------------|---------|---------|------------|------------|
| | BASE CODE | | BENCH SETTINGS | BENCH FINISHES | WALL FINISHES | FRAMING | CEILING | Optional 1 | Optional 2 |



BASE CODE (Digits 1-5)

| Code | 74023 | 74024 | 74026 | 74027 | 74028 |
|---------------------|-------------|-------------|-------------|-------------|-------------|
| Dimensions A-B (cm) | 200x200x220 | 250x200x220 | 250x250x220 | 300x250x220 | 300x300x220 |
| Power | 9 kW | 9 kW | 9 kW | 12 kW | 12 kW |
| Control | Ecotouch | | | | |

BENCH SETTINGS (Digit 6)

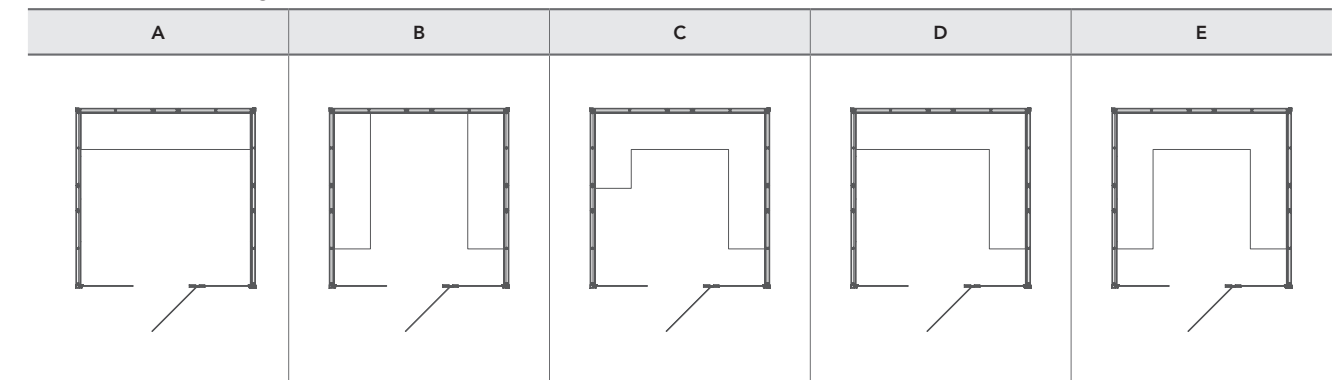

BENCH AND WALL FINISHES (Digits 7-8, 9-10)

| | |
|----|------------------------|
| SR | UNLINED |
| SS | SOLID SURFACE |
| * | LARGE FORMAT PORCELAIN |

* Large format porcelain finishes and codes on pag. 322

FRAMING (Digit 11)

| | |
|---|-----------------------|
| I | Satin stainless steel |
| P | Matte Silver |
| B | Black paint |

CEILING (Digit 12)

| | |
|---|---------------------------------|
| 1 | White methacrylate |
| 2 | Black methacrylate |
| 3 | White methacrylate + LED |
| 4 | Black methacrylate + LED |
| 5 | White methacrylate + starry sky |
| 6 | Black methacrylate + starry sky |

OPTIONALS (Digits 13, 14)

| | |
|---|----------------|
| L | Sink |
| 1 | 1 Puff |
| 2 | 2 Puff |
| B | Water softener |

Ice Cabin

TEMPERATURE ZONE

ASANA

| CODE | 73928 | 73929 | 73930 | 73931 |
|----------------------|---|-------------|-------------|-------------|
| Dimensions A-B (cm) | 250x200x220 | 250x250x220 | 300x250x220 | 300x300x220 |
| Ice Wall | 2,5m | 2,5m | 2,5m | 2,5m |
| Power | 1,85 kW | 1,85 kW | 1,85 kW | 1,85 kW |
| Control | Touch screen | | | |
| Wall finishes | Kelya Porcelain | | | |
| Bench finishes | Sirius Porcelain | | | |
| Accessories finishes | Matte Black | | | |
| Ceiling | Black methacrylate | | | |
| Lighting | Warm white perimeter LED on ceiling and under benches | | | |
| Accessories included | Ice Fountain roof + container | | | |

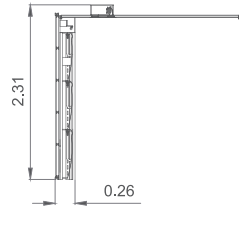
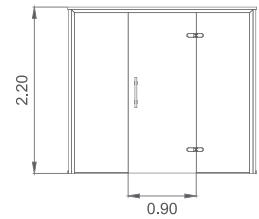
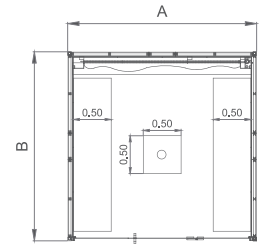

BANDHA

| CODE | 73883 | 73884 | 73885 | 73886 | 73887 |
|----------------------|---|-------------|-------------|-------------|-------------|
| Dimensions A-B (cm) | 250x200x220 | 250x200x220 | 250x250x220 | 300x250x220 | 300x300x220 |
| Ice Wall | 2,0m | 2,5m | 2,5m | 2,5m | 2,5m |
| Power | 1,20 kW | 1,85 kW | 1,85 kW | 1,85 kW | 1,85 kW |
| Control | Touch screen | | | | |
| Wall finishes | Gada Porcelain | | | | |
| Bench finishes | Gada Porcelain | | | | |
| Accessories finishes | Stainless steel | | | | |
| Ceiling | White methacrylate | | | | |
| Lighting | Warm white perimeter LED on ceiling and under benches | | | | |
| Accessories included | Ice Fountain wall + container | | | | |

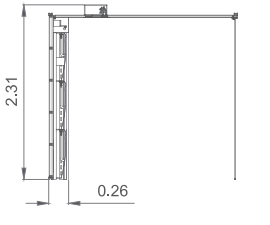
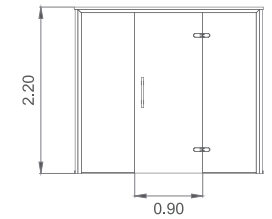
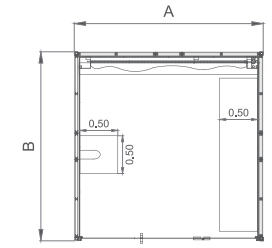

CALA

| CODE | 73932 | 73933 | 73934 | 73935 | 73936 |
|----------------------|---|-------------|-------------|-------------|-------------|
| Dimensions A-B (cm) | 200x200x220 | 250x200x220 | 250x250x220 | 300x250x220 | 300x300x220 |
| Ice Wall | 2,0m | 2,5m | 2,5m | 2,5m | 2,5m |
| Power | 1,20 kW | 1,85 kW | 1,85 kW | 1,85 kW | 1,85 kW |
| Control | Touch screen | | | | |
| Wall finishes | Kreta Porcelain + Sirius | | | | |
| Bench finishes | Kreta Porcelain | | | | |
| Accessories finishes | Stainless steel | | | | |
| Ceiling | Black methacrylate | | | | |
| Lighting | Starry sky + Warm white perimeter LED under bench | | | | |
| Accessories included | Ice Fountain wall + container | | | | |

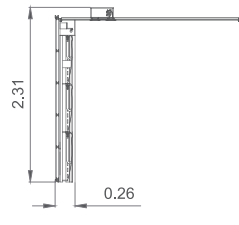
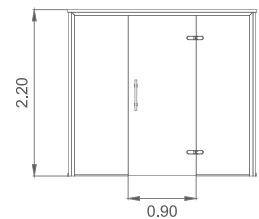
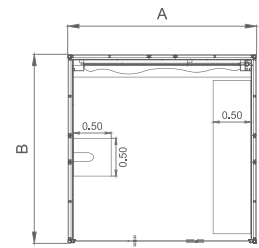

HARA

| CODE | 73888 | 73889 | 73890 | 73891 |
|----------------------|---|-------------|-------------|-------------|
| Dimensions A-B (cm) | 250x200x220 | 250x250x220 | 300x250x220 | 300x300x220 |
| Ice Wall | 2,5m | 2,5m | 2,5m | 2,5m |
| Power | 1,85 kW | 1,85 kW | 1,85 kW | 1,85 kW |
| Control | Touch screen | | | |
| Wall finishes | Radium Porcelain | | | |
| Bench finishes | Niliun Porcelain | | | |
| Accessories finishes | Matte Black | | | |
| Ceiling | Black methacrylate | | | |
| Lighting | Starry sky + Warm white perimeter LED under bench | | | |
| Accessories included | Ice Fountain roof + container | | | |

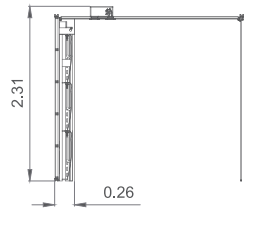
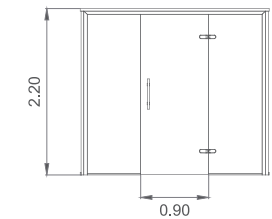
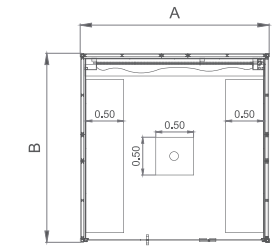

SUTRA

| CODE | 73937 | 73938 | 73939 | 73940 |
|----------------------|---|-------------|-------------|-------------|
| Dimensions A-B (cm) | 250x200x220 | 250x250x220 | 300x250x220 | 300x300x220 |
| Ice Wall | 2,5m | 2,5m | 2,5m | 2,5m |
| Power | 1,85 kW | 1,85 kW | 1,85 kW | 1,85 kW |
| Control | Touch screen | | | |
| Wall finishes | White solid surface | | | |
| Bench finishes | Kairos Porcelain | | | |
| Accessories finishes | Matte Black | | | |
| Ceiling | Black methacrylate | | | |
| Lighting | Warm white perimeter LED on ceiling and under benches | | | |
| Accessories included | Ice Fountain roof + container | | | |

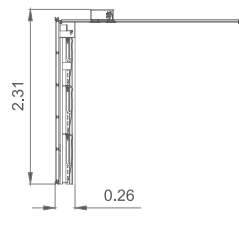
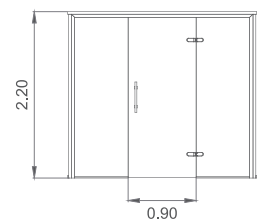
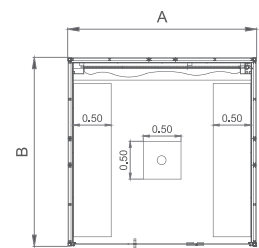

Create your customizable ice room option:

TEMPERATURE ZONE

CUSTOMIZABLE CODE

| DIGITS | 12345 | - | 6 | 7-8 | 9-10 | 11 | 12 | 13 | 14 |
|--------|-----------|---|----------------|----------------|---------------|---------|---------|------------|------------|
| | BASE CODE | | BENCH SETTINGS | BENCH FINISHES | WALL FINISHES | FRAMING | CEILING | Optional 1 | Optional 2 |

CUSTOMIZABLE CODE EXAMPLE

| DIGITS | 74026 | - | C | 3F | SS | B | 5 | - | - |
|--------|-----------|---|----------------|----------------|---------------|---------|---------|------------|------------|
| | BASE CODE | | BENCH SETTINGS | BENCH FINISHES | WALL FINISHES | FRAMING | CEILING | Optional 1 | Optional 2 |



BASE CODE (Digits 1-5)

| Code | 74029 | 74030 | 74031 | 74032 | 74033 |
|---------------------|--------------|-------------|-------------|-------------|-------------|
| Dimensions A-B (cm) | 200x200x220 | 250x200x220 | 250x250x220 | 300x250x220 | 300x300x220 |
| Ice Wall | 2,0m | 2,5m | 2,5m | 2,5m | 2,5m |
| Power | 1,20 kW | 1,85 kW | 1,85 kW | 1,85 kW | 1,85 kW |
| Control | Touch screen | | | | |

BENCH SETTINGS (Digit 6)

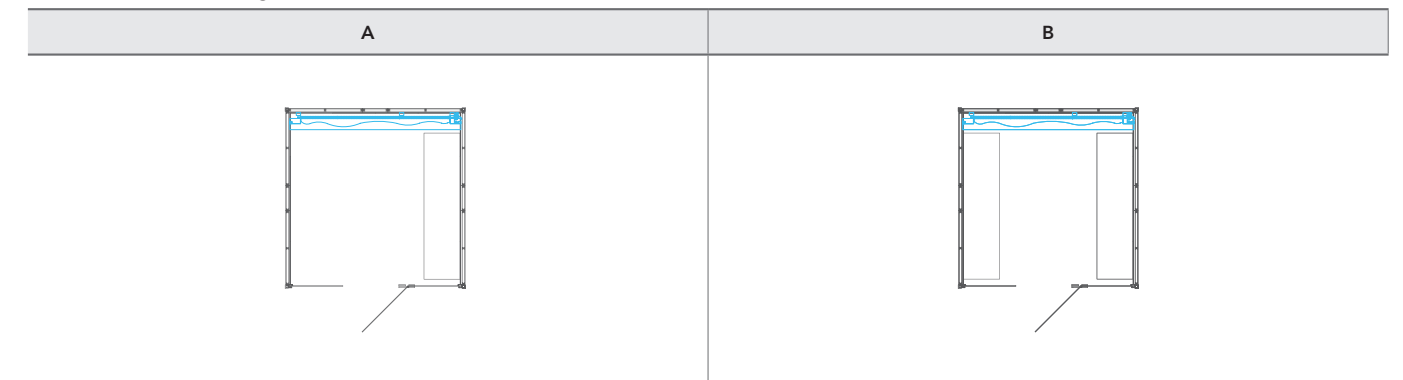

BENCH AND WALL FINISHES (Digits 7-8, 9-10)

| | |
|----|------------------------|
| SR | UNLINED |
| SS | SOLID SURFACE |
| * | LARGE FORMAT PORCELAIN |

* Large format porcelain finishes and codes on pag. 322

FRAMING (Digit 11)

| | |
|---|-----------------------|
| I | Satin Stainless Steel |
| P | Matte Silver |
| B | Black paint |

CEILING (Digit 12)

| | |
|---|---------------------------------|
| 1 | White methacrylate |
| 2 | Black methacrylate |
| 3 | White methacrylate + LED |
| 4 | Black methacrylate + LED |
| 5 | White methacrylate + starry sky |
| 6 | Black methacrylate + starry sky |

OPTIONALS (Digits 13, 14)

| | |
|---|-------------------------------|
| L | Ice container |
| 1 | 1 Puff |
| 2 | 2 Puff |
| H | Ice fountain wall |
| Y | Ice fountain roof |
| J | Ice fountain wall + container |
| K | Ice fountain roof + container |

Ice Fountain

TEMPERATURE ZONE

| CODE | ICE GENERATOR KIT |
|-------|-------------------------|
| 73892 | Stainless steel ceiling |
| 73894 | Matte Black ceiling |
| 73893 | Stainless steel wall |
| 73895 | Matte Black wall |

ICE MAKER MACHINE

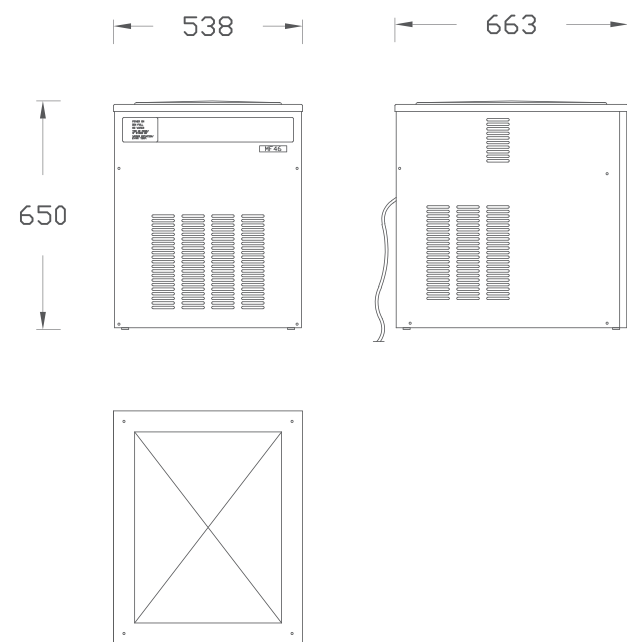

ICE DROP TUBE

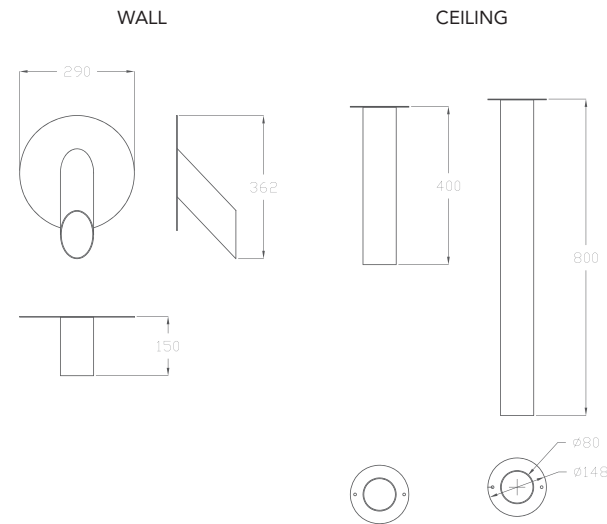

Available in other lengths up to a maximum of 1m
Finishes: Stainless steel or Matte Black

KIT CONTENT - WALL

- Ice Chopping Machine 200 (kg/24h)
- Roof ice dispenser 150x80x2 made of 316 stainless steel with glossy or matte black finish.
- Wall fixing photocell.
- Support brackets for cutting machine.
- Ice level control equipment.
- Ice sink not included.

KIT CONTENT - CEILING

- Ice Chopping Machine 200 (kg/24h)
- Roof ice dispenser 800x129x2 made of 316 stainless steel with glossy or matte black finish.
- Photocell incorporated in tube.
- Support brackets for cutting machine.
- Ice level control equipment.
- Ice sink not included.

| CODE | ICE CONTAINER |
|-------|---------------|
| 73896 | ASANA |
| 73897 | CALA |
| 73898 | SUTRA |
| 73899 | BANDHA |
| 73900 | HARA |
| 74034 | CUSTOMIZABLE |

The customizable option is available in any of the customizable finishes for steam and ice rooms.

ICE CONTAINER

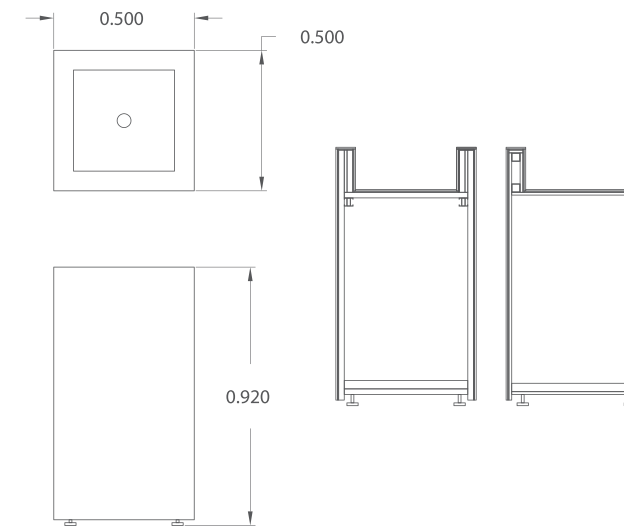

CHARACTERISTICS

Container made of large format porcelain.
Lower base ring in anodized aluminum.
20 L capacity.

- ASANA: Coted in slate black large format porcelain Sirius (group 1)
- BANDHA: Coted in large formats sand porcelain Gada (Group 0).
- CALA: Coted in large gray stone porcelain Kreta (Group 2).
- HARA: Coted in large format porcelain Niliium (Group 2).
- SUTRA: Coted in large format porcelain Kairos (Group 3).

Large format Porcelain

TEMPERATURE ZONE

GROUP 0



0A - Aldem



0B - Blanc concrete



0C - Gada

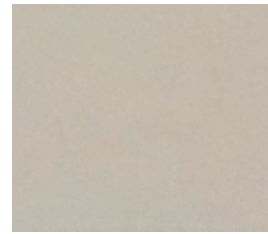

0D - Qatar



0E - Sirocco

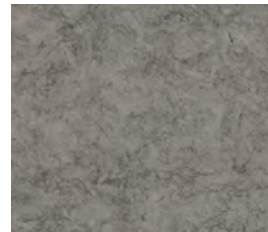

0F - Vegha

GROUP 1

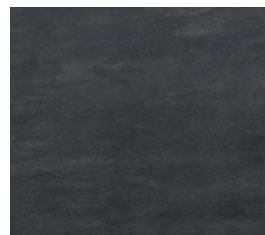

1A - Bromo



1B - Danae



1C - Edora

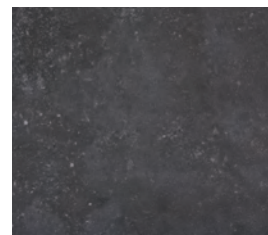

1D - Fossil



1E - Keon



1F - Keranium



1G - Milar



1H - Nayla



1I - Sasea

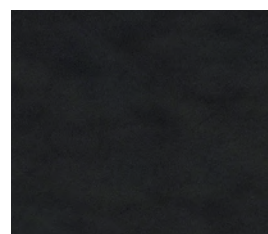

1J - Sirius

GROUP 2



2A - Domoos



2B - Galema



2C - Kelya



2D - Kira



2E - Korus



2F - Kovik



2G - Kreta



2H - Laos



2I - Lunar

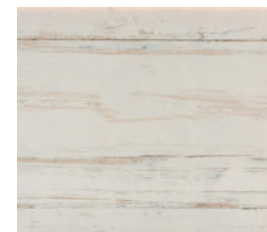

2J - Makai



2K - Manhattan



2L - Nilium



2M - Orix



2N - Radium



2O - Soke



2P - Strato



2Q - Trilium



2R - Ventus



2S - Vera

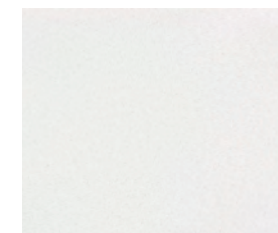

2T - Vienna

Large format Porcelain

TEMPERATURE ZONE

GROUP 3



3A - Aura



3B - Blaze



3C - Entzo



3D - Fiord

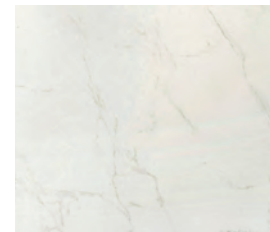

3E - Glacier



3F - Kairos

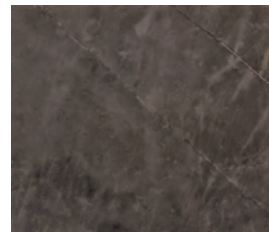

3G - Korso

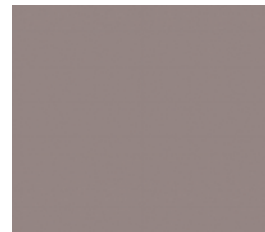

3H - Lumina

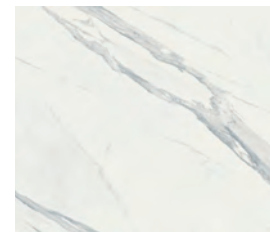

3I - Opera



3J - Portum



3K - Sogne



3L - Splendor



3M - Tundra

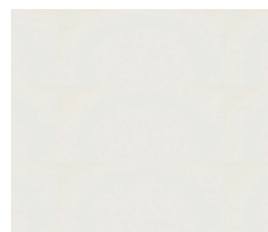

3N - Zenith

Ceramics

TEMPERATURE ZONE

Enhance your ready-to-finish rooms or loungers with AstralPool's range of ceramic tiles.

SIXTIES

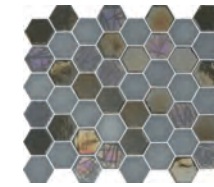

GREY
32 x 29 cm.
12,60" x 11,42"
GREY60F D3



PINK
32 x 29 cm.
12,60" x 11,42"
PINK60F D3

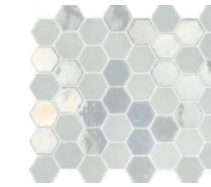

WHITE
32 x 29 cm.
12,60" x 11,42"
WHIT60F D3



BURGUNDY
32 x 29 cm.
12,60" x 11,42"
BURG60F D3

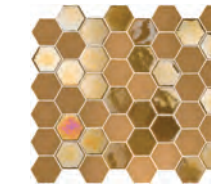

MUSTARD
32 x 29 cm.
12,60" x 11,42"
MUST60F D



KHAKI
32 x 29 cm.
12,60" x 11,42"
KHAK60F D3



PEARL TAUPE
32 x 29 cm.
12,60" x 11,42"
G33560F D3



TAUPE
32 x 29 cm.
12,60" x 11,42"
TAUP60F D3

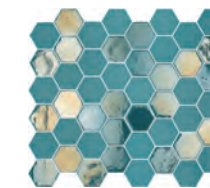

TURQUOISE
32 x 29 cm.
12,60" x 11,42"
TURQ60F D3

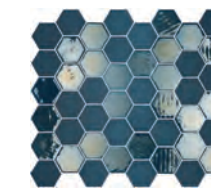

BLUE
32 x 29 cm.
12,60" x 11,42"
BLUE60F D3

SIXTIES MATT



MATT WHITE
32 x 29 cm.
12,60" x 11,42"
MA1860F D3

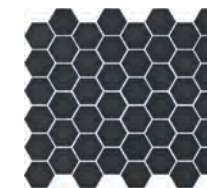

MATT BLACK
32 x 29 cm.
12,60" x 11,42"
MA3060F D3



MATT IVORY
32 x 29 cm.
12,60" x 11,42"
MA3160F D3

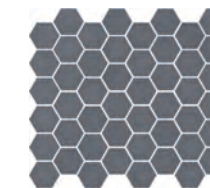

MATT GREY
32 x 29 cm.
12,60" x 11,42"
MA2260F D3

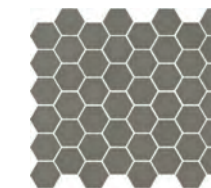

MATT TAUPE
32 x 29 cm.
12,60" x 11,42"
MA2360F D3

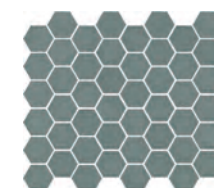

MATT KHAKI
32 x 29 cm.
12,60" x 11,42"
MA2160F D3



MATT BLUE
32 x 29 cm.
12,60" x 11,42"
MA2660F D3

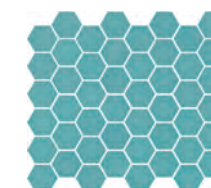

MATT TURQUOISE
32 x 29 cm.
12,60" x 11,42"
MA2060F D3

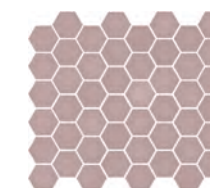

MATT PINK
32 x 29 cm.
12,60" x 11,42"
MA1960F D3

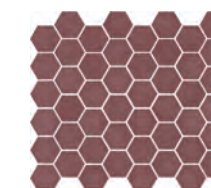

MATT BURGUNDY
32 x 29 cm.
12,60" x 11,42"
MA2560F D3

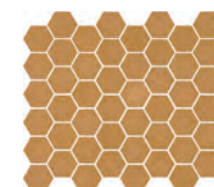

MATT MUSTARD
32 x 29 cm.
12,60" x 11,42"
MA2460F D3

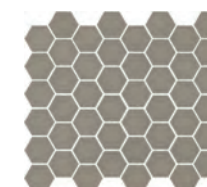

MATT SAND
32 x 29 cm.
12,60" x 11,42"
MA3260F D3

Ceramics

TEMPERATURE ZONE

IRON 5X5

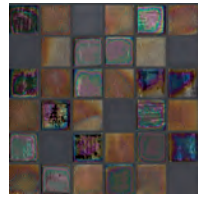

GOLD
31 x 31 cm.
12,20" x 12,20"
GOLD50F B10

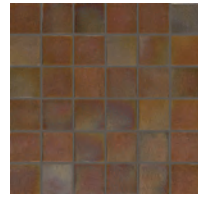

OXID
31 x 31 cm.
12,20" x 12,20"
OXID50F B10

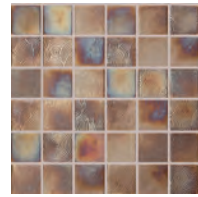

BRONZE
31 x 31 cm.
12,20" x 12,20"
BRON50F B10

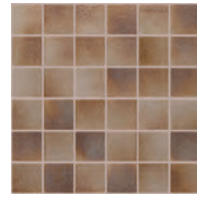

COPPER
31 x 31 cm.
12,20" x 12,20"
COPP50F B9

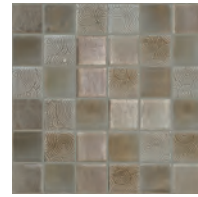

SILVER
31 x 31 cm.
12,20" x 12,20"
SILV50F B10

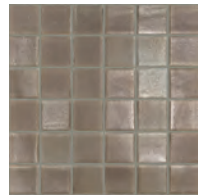

STEEL
31 x 31 cm.
12,20" x 12,20"
STEE50F B9

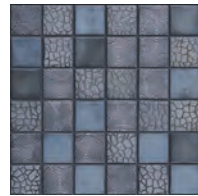

HERMES 5X5
31 x 31 cm.
12,20" x 12,20"
HERM50F B10

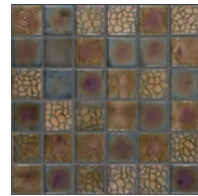

TERRA 5X5
31 x 31 cm.
12,20" x 12,20"
TERR50F B10

MIX DECOR

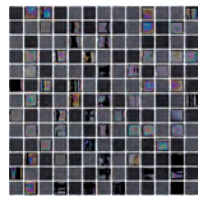

TOKYO
33,4 x 33,4 cm.
13,15" x 13,15"
33% MA09
33% MT05
33% G312
TOKY25Y L5

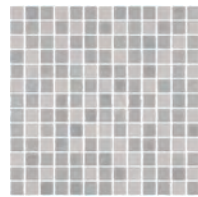

MILAN
33% MA13
33% MT07
33% G329
MILA25Y L5

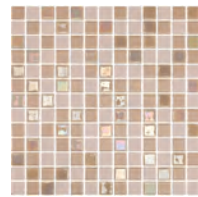

DURBAN
33,4 x 33,4 cm.
13,15" x 13,15"
33% MA14
33% MT08
33% G330
DURB25Y L5

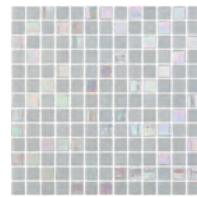

PARIS
33,4 x 33,4 cm.
13,15" x 13,15"
33% WHITE FOG
33% MT04
33% G305
PARI25Y L4

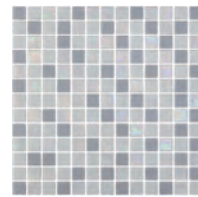

SYDNEY
33,4 x 33,4 cm.
13,15" x 13,15"
33% WHITE FOG
33% MT01
33% G328
SYDN25Y L4

SILK/SILK

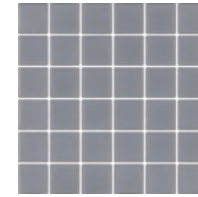

558 ANTI-SLIP
31 x 31 cm.
12,20" x 12,20"
055850A B8

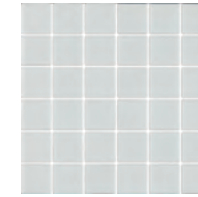

WHITE ANTI-SLIP
31 x 31 cm.
12,20" x 12,20"
BNCO50A B8

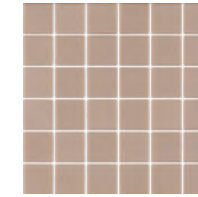

SAND ANTI-SLIP
31 x 31 cm.
12,20" x 12,20"
AREN50A B8

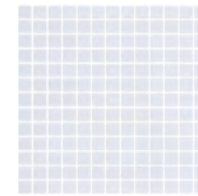

WHITE ANTI-SLIP
33,4 x 33,4 cm.
13,15" x 13,15"
BNCO25AY B1

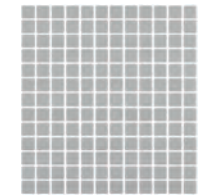

LIGHT GREY ANTI-SLIP
33,4 x 33,4 cm.
13,15" x 13,15"
GRCL25AY B3

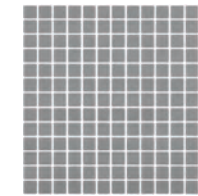

258 ANTI-SLIP
33,4 x 33,4 cm.
13,15" x 13,15"
025825AY B3

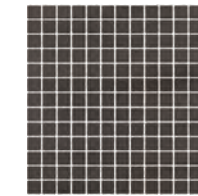

BLACK ANTI-SLIP
33,4 x 33,4 cm.
13,15" x 13,15"
NEGR25AY B3

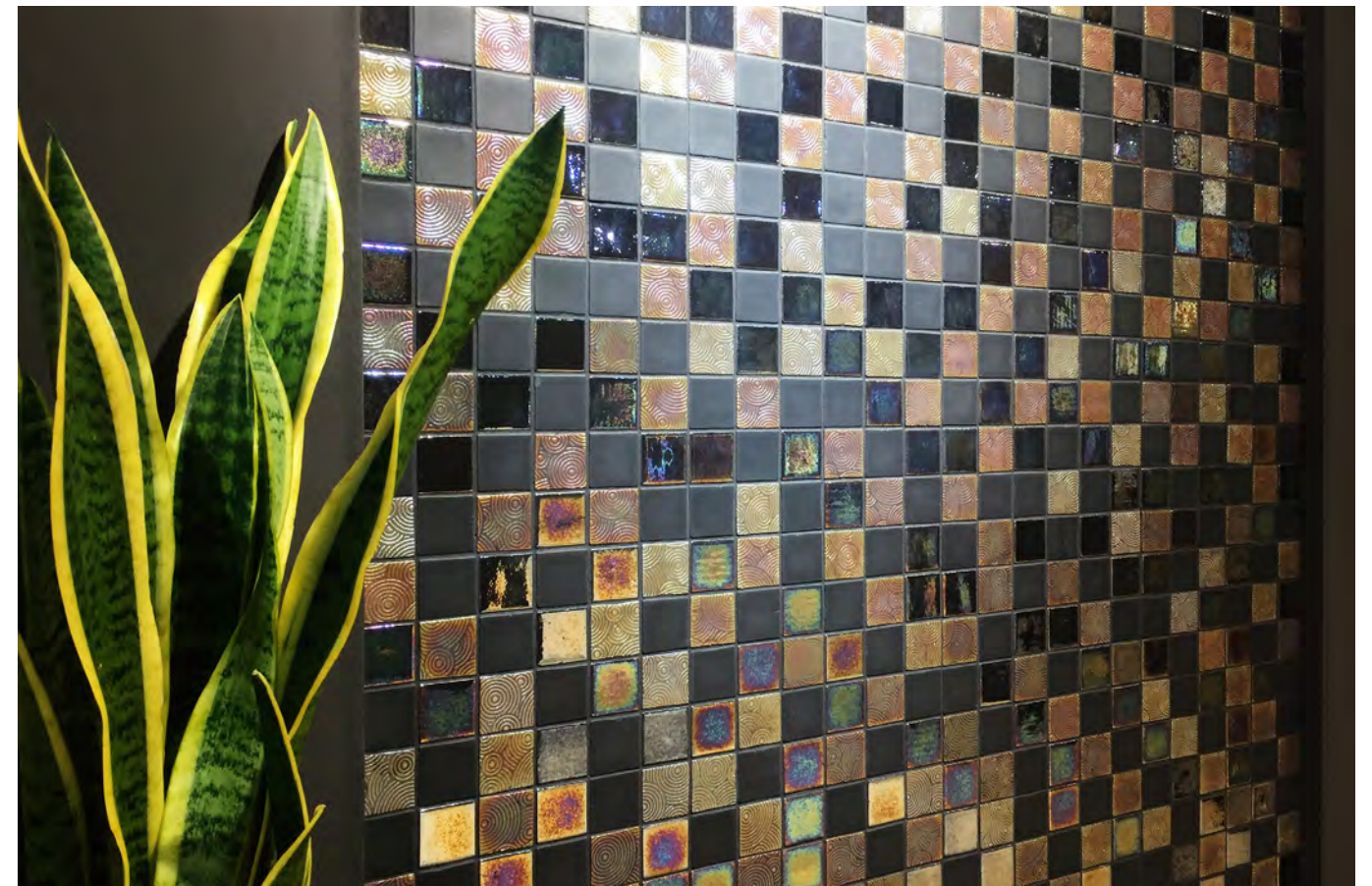

Snow Machine

TEMPERATURE ZONE

| MODEL | SNOWFALL 05L | SNOWFALL 08W | SNOWFALL 16W | SNOWFALL 25W | SNOWFALL 32W |
|---------------------|----------------------------|---------------------------|---------------------------|---------------------------|--|
| CODE | 73945 | 73946 | 73947 | 73948 | 73949 |
| GENERAL | | | | | |
| Size | 650 x 650 x 437mm | 910 x 830 x 480mm | 910 x 830 x 480mm | 910 x 830 x 900mm | 2 x 910 x 830 x 480mm 1 x 680 x 830 x 480mm |
| Size (condenser) | 650 x 650 x 468mm | | | | |
| Weight | 80 kg | 90 kg | 90 kg | 125 kg | 190 kg |
| Refrigeration | Air | Water | Water | Water | Water |
| Connection | 230 V | 230 V | 230 V | 400 V | 400 V |
| Power | 0,9 kW / 3,4A | 0,9 kW / 7,2A | 1,1 kW / 7,2A | 2,4 kW / 4,5A | 2,8 kW / 5,1A |
| SNOW | | | | | |
| Quality | Natural | Natural | Natural | Natural | Natural |
| Weight | appx 140kg/m ³ | appx 140kg/m ³ | appx 140kg/m ³ | appx 140kg/m ³ | appx 140kg/m ³ |
| Flow | appx 0,7 m ³ /d | appx 1,2m ³ /d | appx 2,3m ³ /d | appx 3,4m ³ /d | appx 4,6m ³ /d |
| TEMPERATURE | | | | | |
| Snow coverage | max. +45°C | max. +45°C | max. +45°C | max. +45°C | max. +45°C |
| Installation space | max. +35°C | max. +35°C | max. +35°C | max. +35°C | max. +35°C |
| OPTIONAL | | | | | |
| Snow / LED Lighting | ✓ | ✓ | ✓ | ✓ | ✓ |
| Snow height sensor | ✓ | ✓ | ✓ | ✓ | ✓ |
| Auto on/off | ✓ | ✓ | ✓ | ✓ | ✓ |





Technical characteristics

Al-Haya
WATER ZONE

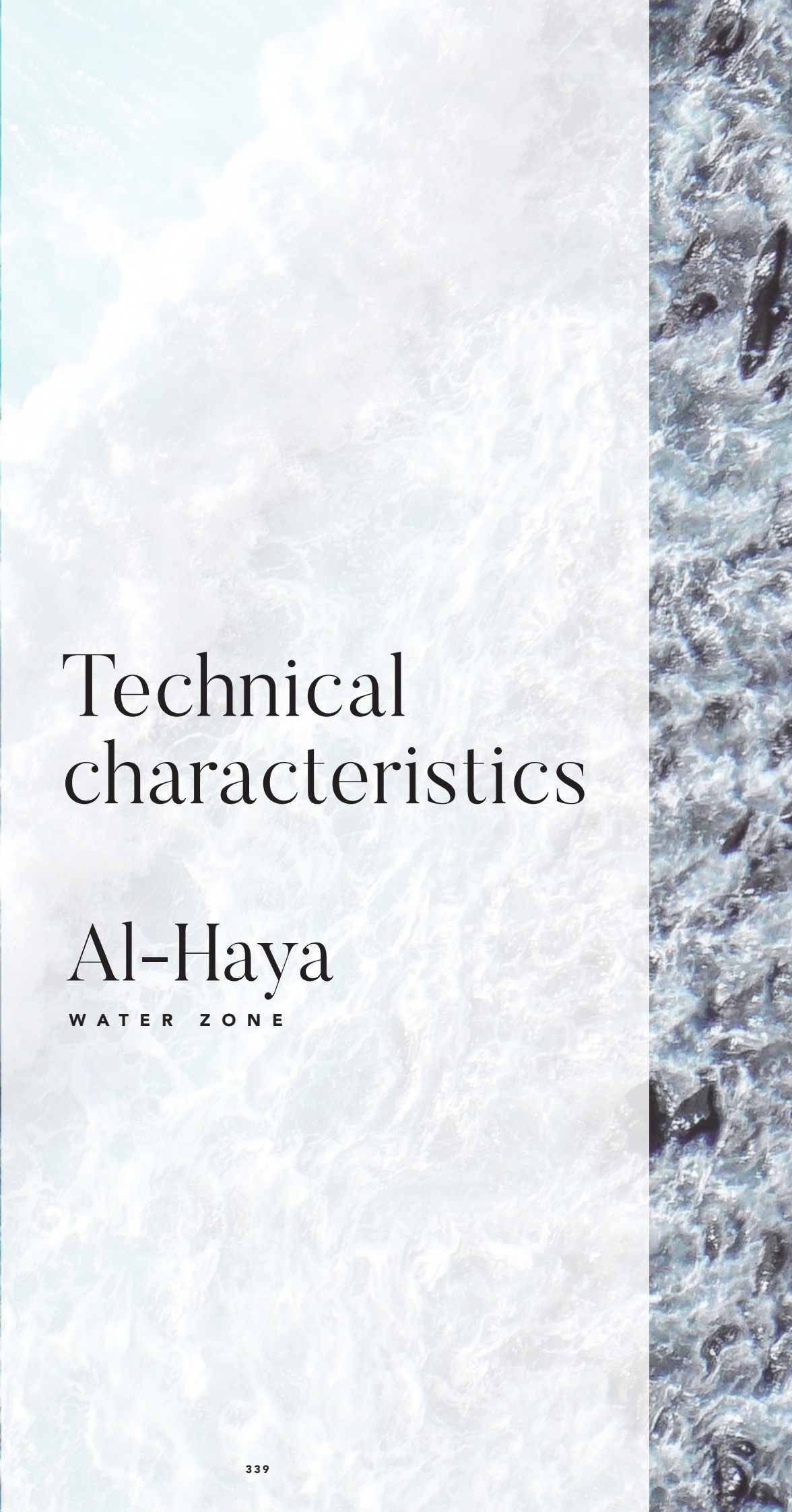

Emotional Showers

W A T E R Z O N E

| CODE | DESCRIPTION | LIGHTING | JETS | SIZE (cm) | CONTROL | OPTIONALS |
|----------|-------------|----------|------|-----------|-------------------|-----------|
| AF-FL001 | SENSE PRO | RGB | | 70 x 70 | 4 preset programs | - - - |

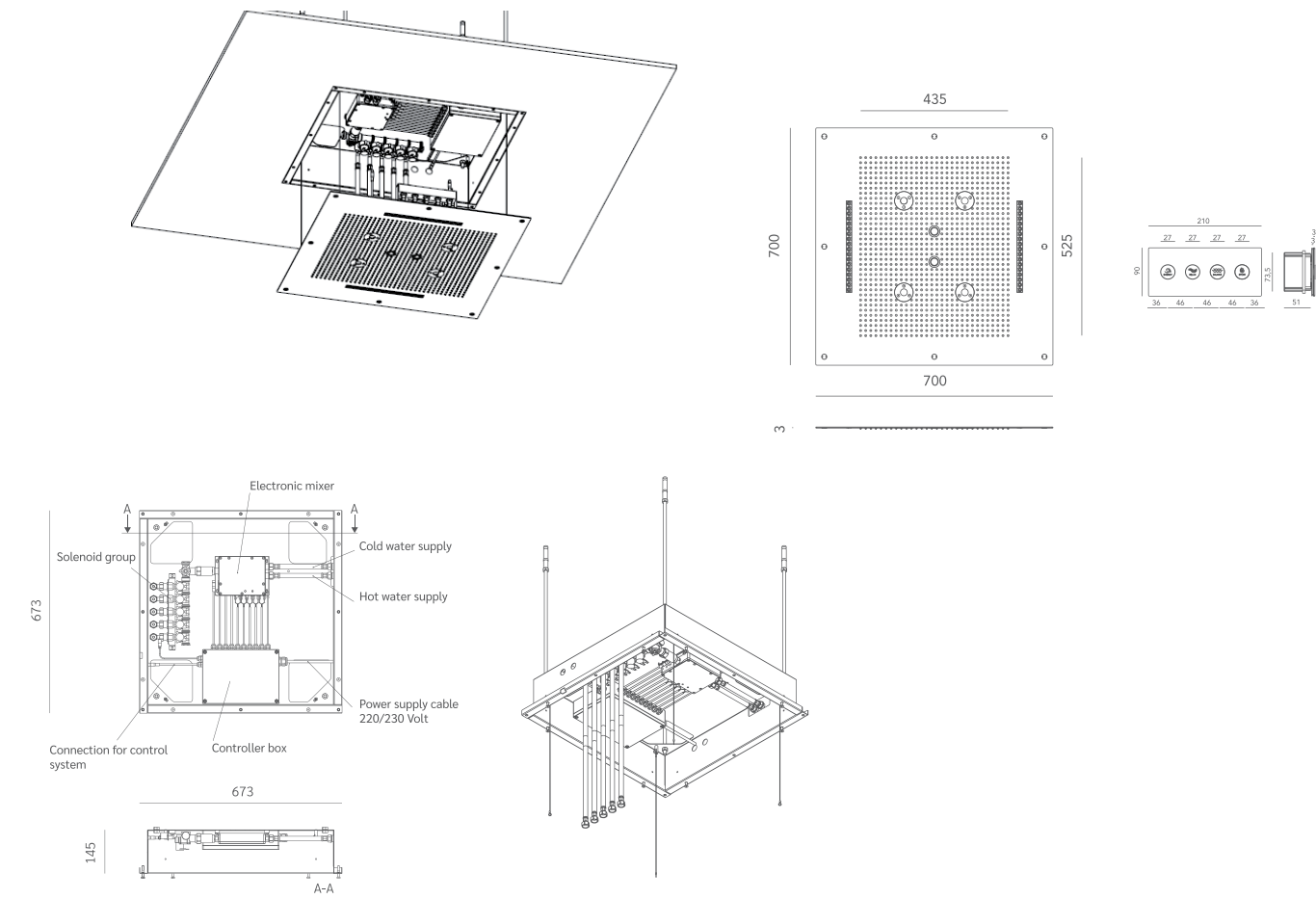

- Square shower head for recessed installation 700x700 mm.
- Complete kit with control box for jets, lights, water temperature, and installation system. Includes built-in wall-mounted IP67 keypad in stainless steel with 4 buttons and 7-module flush mount box (type 506) with electronic control to manage 4 pre-configured programs: Relax, Energy, Balance, Sport. 12V load transformer.
- Materials: stainless steel plate with ultra-mirror finish, liquid silicone anti-lime membrane.
- Ceiling depth: 150 mm.
- Water supply 1/2" (inch)
- Operating pressure: 1.5 / 5 bar.
- Recommended pressure: 3 bar.

| CODE | DESCRIPTION | LIGHTING | JETS | SIZE (cm) | CONTROL | OPTIONALS |
|----------|---------------------|----------|------|-----------|---------------------|-----------|
| AF-FL002 | AQUA SEQUENCE | RGB | | 70 x 70 | Sequence (1 button) | |
| AF-FL003 | AQUA SEQUENCE WHITE | WHITE | | | | |
| AF-FL004 | AQUA SEQUENCE NUDE | - | | | | |
| AF-FL005 | AQUA | RGB | | 70 x 70 | Manual (4 buttons) | |
| AF-FL006 | AQUA WHITE | WHITE | | | | |
| AF-FL007 | AQUA NUDE | - | | | | |

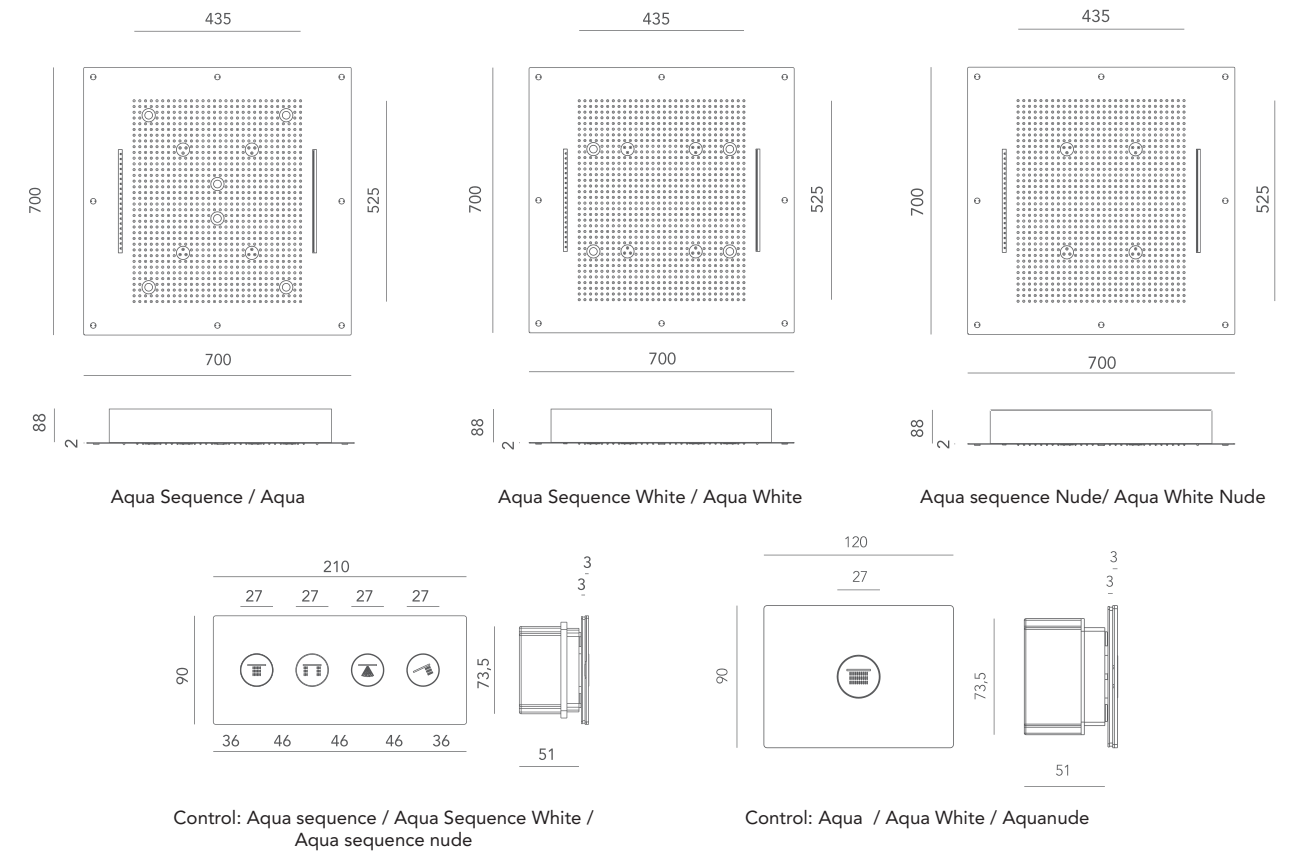

- Square shower head for recessed installation 700x700 mm. 4 water patterns: 1 rain jet, 4 mist jets, 1 tropical jet, and 1 waterfall jet.
- Aqua sequence and Aqua: includes 6 LED lights with chromotherapy.
- Aqua White sequence White and Aqua White: includes 4 LED bench lights.
- Ultra-mirror stainless steel plate, liquid silicone anti-lime membrane.
- Ceiling depth: 100 mm.
- Water supply 1/2" (inch)
- Operating pressure: 1.5 / 5 bar.
- Recommended pressure: 3 bar.
- Complete kit with installation system.

Emotional Showers

W A T E R Z O N E

| CODE | DESCRIPTION | LIGHTING | JETS | | | | SIZE (cm) | CONTROL | OPTIONALS | | |
|----------|-------------------------|----------|------|--|--|---|-----------|---------------------|-----------|--|--|
| AF-FL008 | INFINITY SEQUENCE | RGB | | | | | | | | | |
| AF-FL009 | INFINITY SEQUENCE WHITE | WHITE | | | | - | 42 x 42 | Sequence (1 button) | | | |
| AF-FL010 | INFINITY SEQUENCE NUDE | - | | | | | | | | | |
| AF-FL011 | INFINITY | RGB | | | | | | | | | |
| AF-FL012 | INFINITY WHITE | WHITE | | | | - | 42 x 42 | Manual (3 buttons) | | | |
| AF-FL013 | INFINITY NUDE | - | | | | | | | | | |

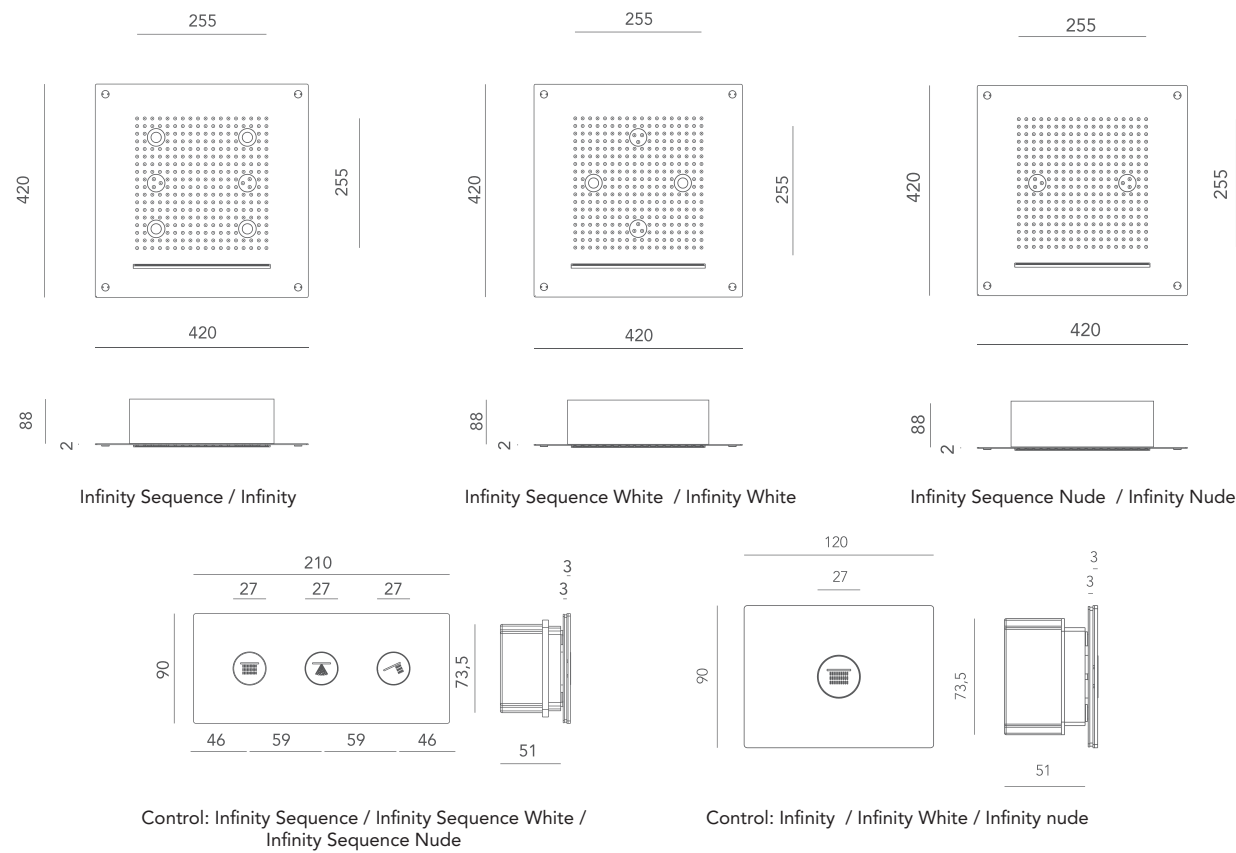

- Square shower head for recessed ceiling installation 420 x 420 mm. 3 water patterns: 1 rain jet, 2 mist jets and 1 waterfall jet.
- Infinity sequence and Infinity: includes 4 LED lights with chromotherapy.
- Infinity sequence White and Infinity White: includes 2 white LED lights.
- Ultra-mirror stainless steel plate, liquid silicone anti-lime membrane.
- Ceiling depth: 100 mm.
- Water supply: 1/2" (inch)
- Operating pressure: 1,5 / 5 bar.
- Recommended pressure: 3 bar.
- Complete kit with installation system.



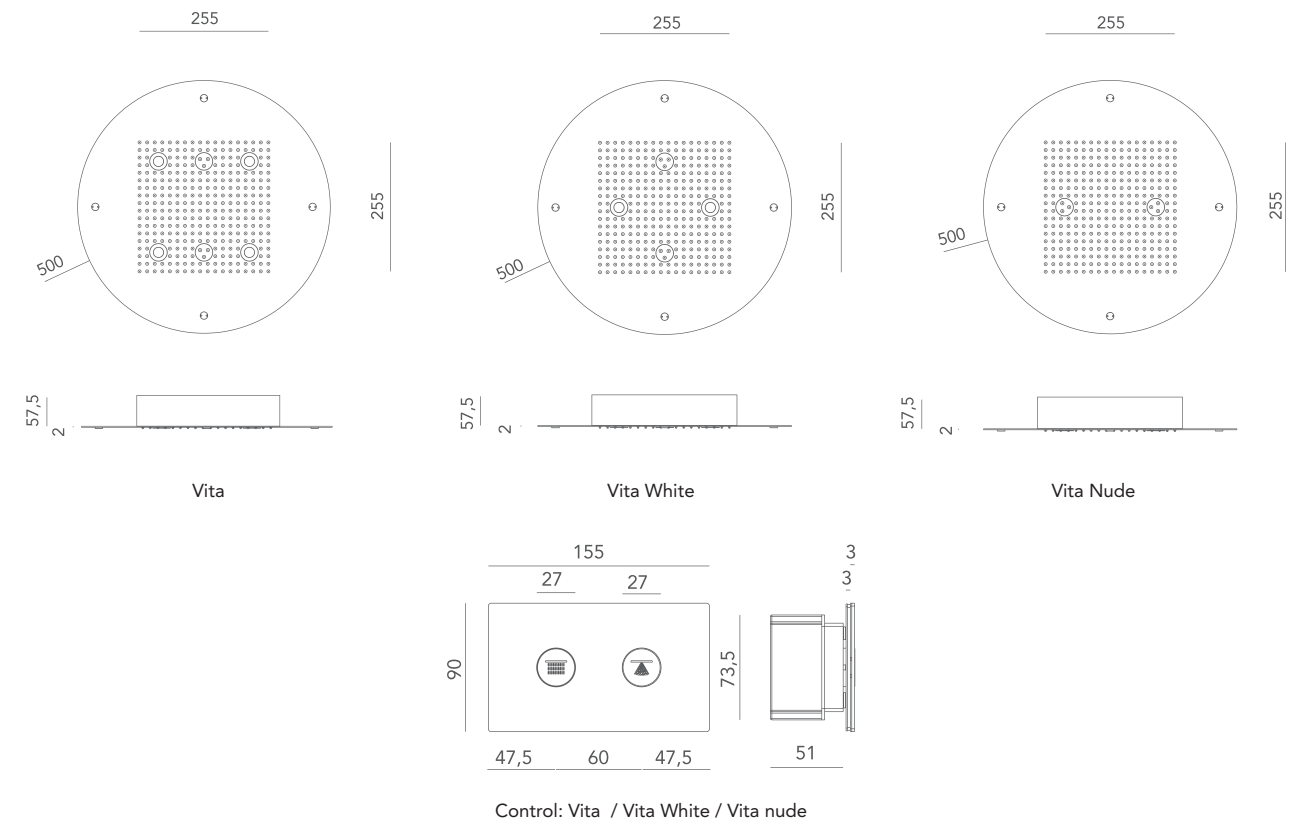





| CODE | DESCRIPTION | LIGHTING | JETS | | | | SIZE (cm) | CONTROL | OPTIONALS | | |
|----------|-------------|----------|------|--|---|---|-----------|--------------------|-----------|--|--|
| AF-FL014 | VITA | RGB | | | | | | | | | |
| AF-FL015 | VITA WHITE | WHITE | | | - | - | Ø50 | Manual (2 buttons) | | | |
| AF-FL016 | VITA NUDE | - | | | | | | | | | |



- Rounded shower head for recessed ceiling installation Ø500 mm. 2 water patterns: 1 rain jet and 2 mist jets.
- Infinity sequence and Infinity: includes 4 LED lights with chromotherapy.
- Infinity sequence White and Infinity White: includes 2 white LED lights.
- Ultra-mirror stainless steel plate, liquid silicone anti-lime membrane.
- Ceiling depth: 100 mm.
- Water supply: 1/2" (inch)
- Operating pressure: 1,5 / 5 bar.
- Recommended pressure: 3 bar.
- Complete kit with installation system.

Emotional Tunnels





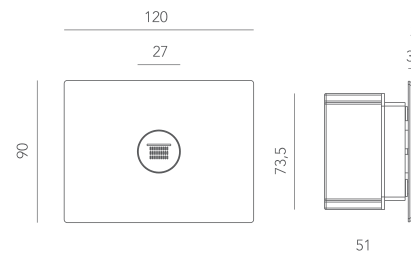
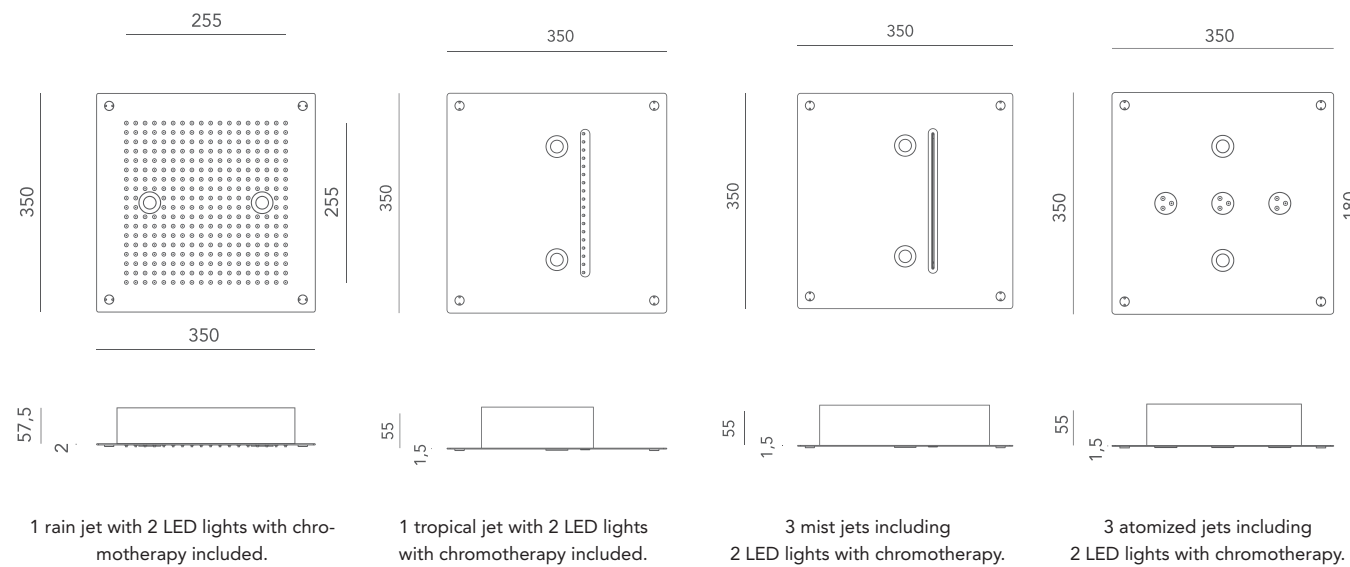



WATER ZONE

| CODE | DESCRIPTION | LIGHTING | JETS | SIZE (cm) | CONTROL | OPTIONALS |
|----------|-------------|----------|---|-----------|--|---|
| AF-FL033 | AQUA | RGB |     | 42 x 42 | 1 button  |    |



Sequence activation with button.
(Optional: reverse path)

- Materials: Ultra-mirror stainless steel plate, liquid silicone anti-lime membrane.
- Ceiling depth: 100 mm.
- Water supply: 1/2" (inch)
- Operating pressure: 1,5 / 5 bar.
- Recommended pressure: 3 bar.
- The inverted path accessory (not included) makes it possible to run the sequence in reverse.

| CODE | DESCRIPTION | LIGHTING | JETS | SIZE (cm) | CONTROL | OPTIONALS |
|----------|-------------|----------|---|-------------|--|---|
| AF-FL034 | INFINITY | RGB |     | 5 x 35 x 15 | 1 button  |    |

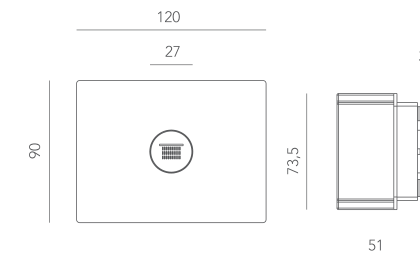
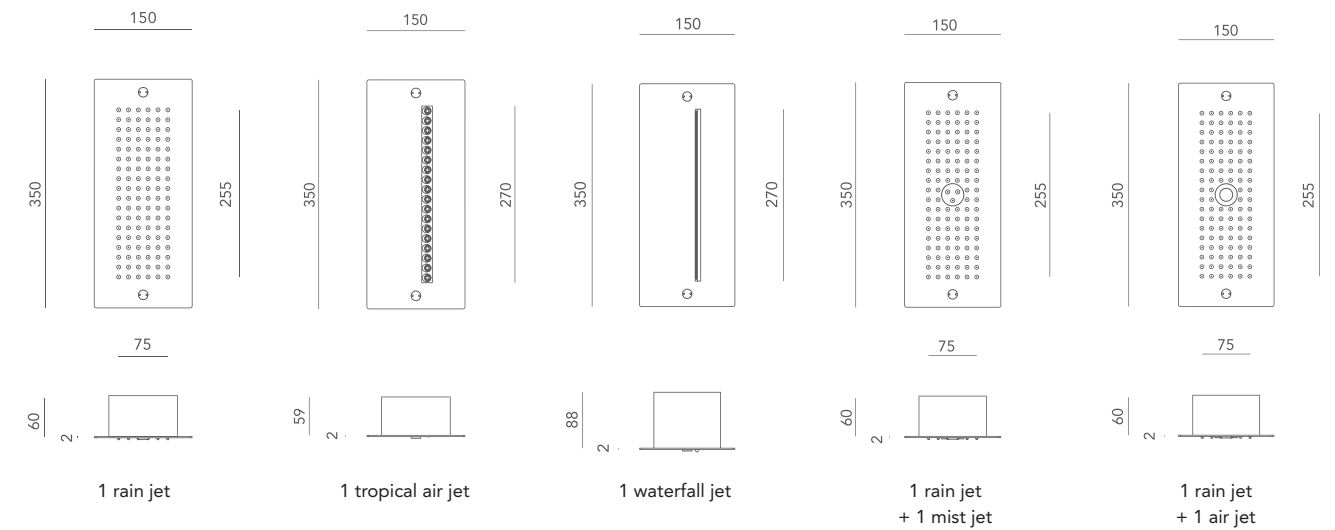

Sequence activation with button.
(Optional: reverse path)

- Materials: Ultra-mirror stainless steel plate, liquid silicone anti-lime membrane.
- Ceiling depth: 100 mm.
- Water supply: 1/2" (inch)
- Operating pressure: 1,5 / 5 bar.
- Recommended pressure: 3 bar
- The inverted path accessory (not included) makes it possible to run the sequence in reverse.

Emotional Tunnels

W A T E R Z O N E

| CODE | DESCRIPTION | LIGHTING | JETS | SIZE (cm) | CONTROL | OPTIONALS |
|----------|-------------|----------|------|----------------------------|----------|-----------|
| AF-FL035 | VITA | RGB | | 2 x 35 x 15 1 x 35 x 35 | 1 button | |

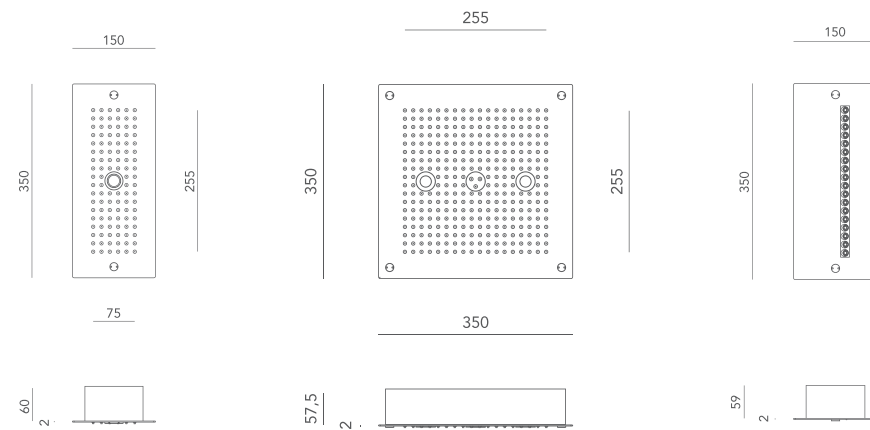

1 rain jet and 1 air jet

1 rain jet and 1 mist jet including 2 LED lights with chromotherapy.

1 rain jet

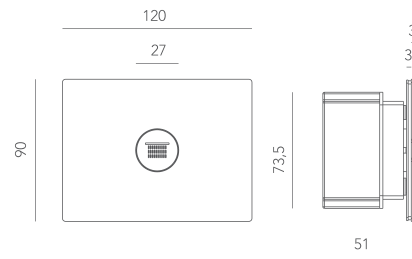



1 air tropical jet

- Materials: Ultra-mirror stainless steel plate, liquid silicone anti-lime membrane.
- Ceiling depth: 100 mm.
- Water supply: 1/2" (inch)
- Operating pressure: 1,5 / 5 bar.
- Recommended pressure: 3 bar.
- The inverted path accessory (not included) makes it possible to run the sequence in reverse.





Contrast Showers

W A T E R Z O N E

| CODE | DESCRIPTION | LIGHTING | JETS | OPTIONALS |
|----------|------------------------|----------|---|---|
| AF-FL037 | COLD - CONTRAST SHOWER | RGB |  |  |



- Built-in round chrome bodyjet with sequential control, with nebulized jet. Includes RGB led for chromotherapy and control of temperature.
- Water supply connection: 1/2" inch
- Absorption 350 mA

| CODE | DESCRIPTION | LIGHTING | JETS | OPTIONALS |
|----------|------------------------------|----------|--|---|
| AF-FL038 | HOT & COLD - CONTRAST SHOWER | RGB |  |  |

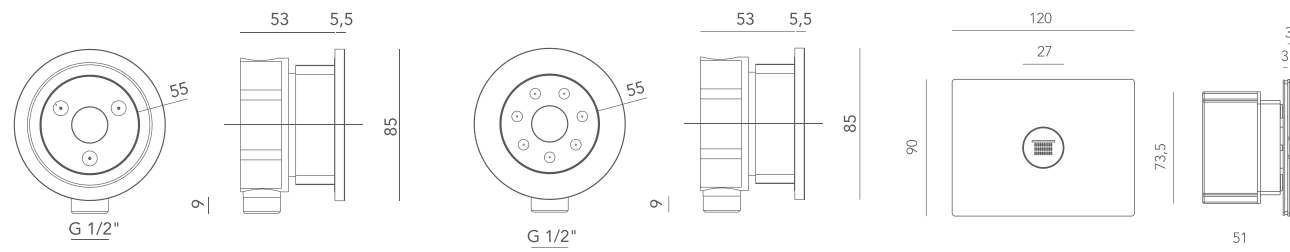

- Built-in round chrome bodyjet with sequential control, with nebulized and atomized jet. Includes RGB led for chromotherapy and control of temperature.
- Water supply connection: 1/2" inch
- Absorption 350 mA

| CODE | DESCRIPTION |
|-------|-------------|
| 87038 | CUBE SHOWER |

- Cube attached to the wall or ceiling.
- Capacity: 4.5 - 7.5 liters
- Size of upper diameter: 305 mm
- Height: 270mm
- Chain height: 630mm
- Pivot radius: 480mm
- Pipe connection: 1/2"

Horizontal Shower

W A T E R Z O N E

| CODE | DESCRIPTION | LIGHTING | JETS |
|----------|-------------------|----------|---|
| AF-FL036 | HORIZONTAL SHOWER | RGB |  |

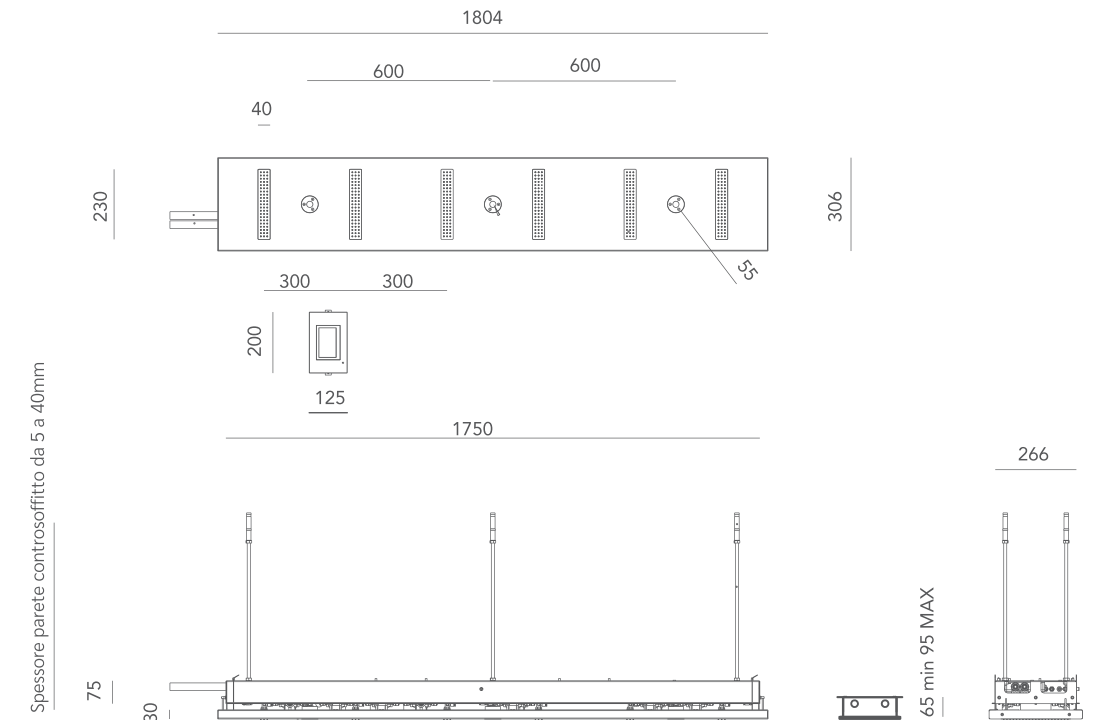

Horizontal shower and massage, in mirror-finish stainless steel, for mounting on the ceiling, with electronic water mixer, chromotherapy and touch control panel to manage 4 pre-configured programs (sport, energy, relaxation, balance) or manual start.

Hydraulic characteristics:

- Water supply works with hot and cold water.
- Pressure 2 ÷ 5 bar.
- Recommended pressure 3 bar.
- For pressures higher than 5 bar, we suggest installing a pressure reducer.
- Cold water temperature 10 ° ÷ 15 ° C
- Hot water temperature 55 ° ÷ 65 ° C
- Optimum hot water flow 15 l / m.

NB:

- A drainage of water in the ground is necessary to release the flow of water.
- It is suggested to install a water softener for water with hardness higher than 15/18 degrees F°

Electrical characteristics:

- Electrical supply 100-240V - 50 ÷ 60Hz
- 12V operation control panel.
- Maximum absorption 100W
- We suggest installing a dedicated RCCB.

Kneipp Path

W A T E R Z O N E

| CODE | DESCRIPTION | LIGHTING | JETS | OPTIONALS |
|----------|-----------------|----------|------|-----------|
| AF-FL039 | 3 METERS KNEIPP | RGB | | |

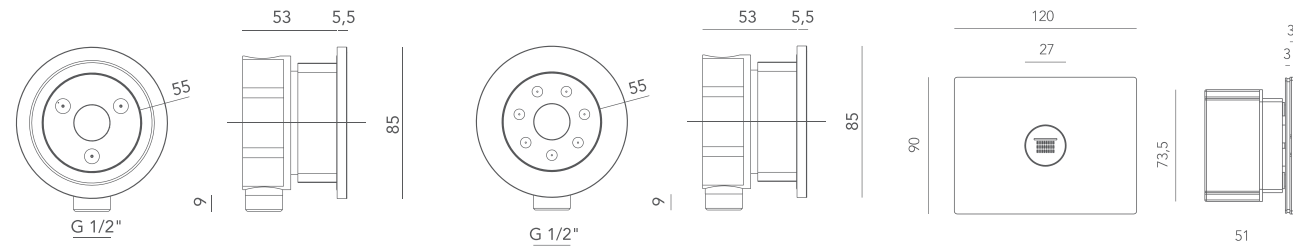

- 8 bodyjets (4 mist + 4 atomized) built in chrome plated brass with sequence control.
- Led RGB for chromotherapy and manual temperature control is included.
- Water supply connection: 1/2" inch
- Absorption 350 mA

| CODE | DESCRIPTION | LIGHTING | JETS | OPTIONALS |
|----------|-----------------|----------|------|-----------|
| AF-FL040 | 5 METERS KNEIPP | RGB | | |

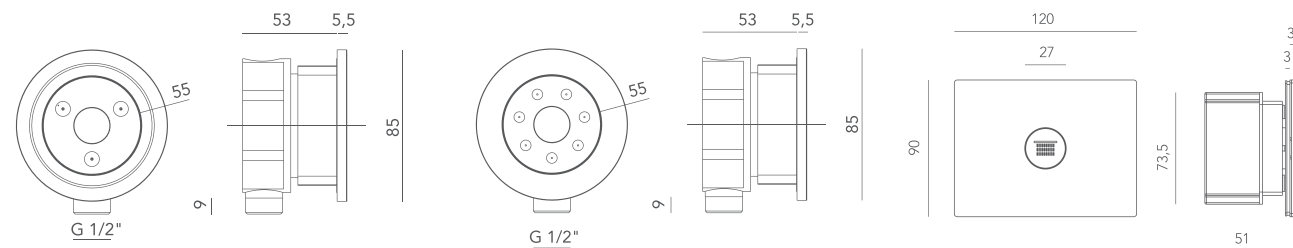

- 16 bodyjets (8 mist + 8 atomized) built in chrome plated brass with sequence control.
- Led RGB for chromotherapy and manual temperature control is included.
- Water supply connection: 1/2" inch
- Absorption 350 mA

| CODE | DESCRIPTION | LIGHTING | JETS | OPTIONALS |
|----------|-----------------|----------|------|-----------|
| AF-FL041 | 9 METERS KNEIPP | RGB | | |

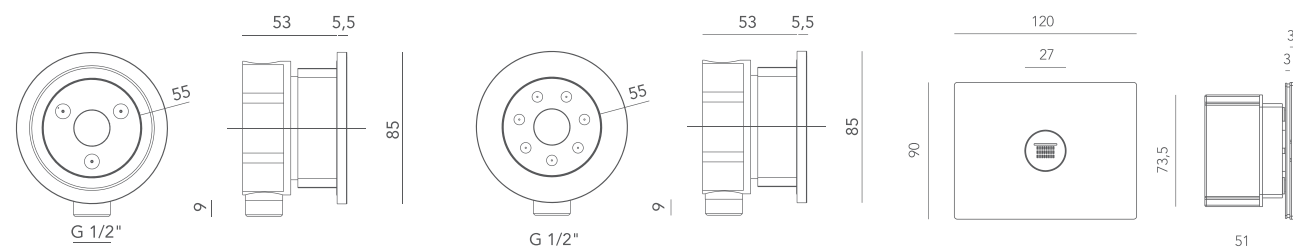

- 32 bodyjets (16 mist + 16 atomized) built in chrome plated brass with sequence control.
- Led RGB for chromotherapy and manual temperature control is included.
- Water supply connection: 1/2" inch
- Absorption 350 mA

Mini contrast pools

W A T E R Z O N E

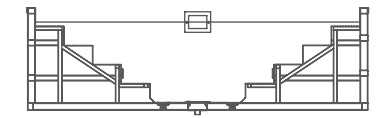
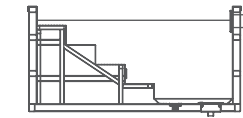

| MODEL | COLD PLUNGE ONE | COLD PLUNGE TWO |
|---------------------------------|----------------------|----------------------|
| CODE | 71482 | 71483 |
| GENERAL SPECIFICATIONS | | |
| Internal dimensions | 2,00 x 0,80 x 0,85 m | 3,40 x 0,80 x 0,85 m |
| External dimensions | 2,18 x 0,98 x 1,08 m | 3,58 x 0,98 x 1,08 m |
| Positions (Seats / Loungers) | - | - |
| Water capacity | 0,90 m ³ | 1,33 m ³ |
| Empty weight / Full Weight | 300 / 1200 kg | 400 / 1730 kg |
| CHARACTERISTICS | | |
| No. Massage jets (water) | - | - |
| No. Air nozzles (air) | - | - |
| Overflow / Skimmer | Skimmer | Skimmer |
| Overflow suction | - | - |
| Return inlet | 1 | 2 |
| Bottom cleaner nozzles | 1 | 1 |
| Main drain | 1 | 1 |
| Headrests | - | - |
| LED projectors | 1 | 2 |
| Piezoelectric button | No | No |
| OPTIONS (NOT INCLUDED) | | |
| Stainless steel overflow grille | No | No |
| Wooden overflow grille | No | No |
| Isolating cover | No | No |
| RECOMMENDED EQUIPMENT | | |
| Compact filtration kit | No | No |
| Balance tank | No | No |

Vitality pool

W A T E R Z O N E

Vitality pool made of stainless steel with overflow
5x3x1,2 m

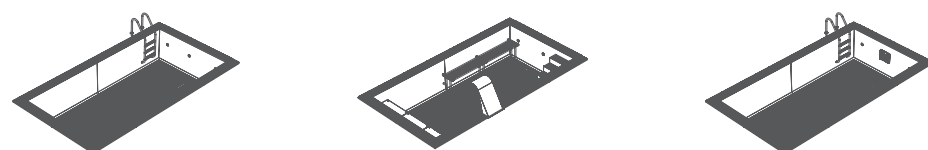

| MODEL | OPTIMAL | WELLNESS | SPORT |
|-------------------------------|--------------------|--------------------|--------------------|
| CODE | 71501 | 71502 | 71503 |
| GENERAL SPECIFICATIONS | | | |
| Internal dimensions | 5 x 2,85 x 1,2 m | | |
| External dimensions | 5,7 x 3,6 x 1,3 m | | |
| Water capacity | 18 m ³ | | |
| Empty weight / Full Weight | 2300 Kg - 20300 Kg | 2550 Kg - 20550 Kg | 2300 Kg - 20300 Kg |
| CHARACTERISTICS | | | |
| Skimmers | - | - | - |
| Overflow suction | 2 | 2 | 2 |
| Return inlet | 3 | 4 | 3 |
| Bottom cleaner nozzles | 1 | 1 | 1 |
| Main drain | 2 | 2 | 2 |
| Projectors | 2 | 2 | 2 |
| ACCESSORIES | | | |
| Ladder (3 steps) | ✓ | - | ✓ |
| Steps | - | ✓ | - |
| Hydromassage bench | - | ✓ | - |
| Hydromassage cascade | - | ✓ | - |
| Hydromassage water jet | - | ✓ | - |
| Hydromassage beds | - | - | - |
| Countercurrent equipment | - | - | ✓ |
| Cover | - | ✓ | - |
| RECOMMENDED EQUIPMENT | | | |
| Hydraulic button and timer | - | 45218 + 35761 | - |
| Blower pump for hydro beds | - | - | - |
| Blower pump for hydro bench | - | 35388 | - |
| Filtration equipment | 27804 | | |

Vitality pool made of stainless steel with overflow
7x3x1,2 m

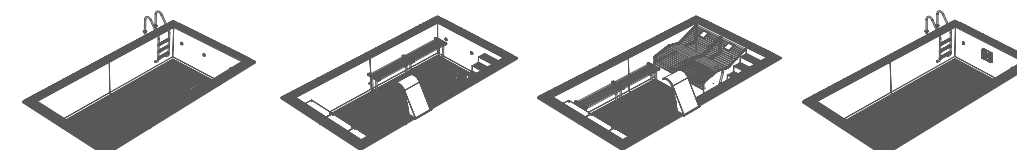

| MODEL | OPTIMAL | WELLNESS | COMFORT | SPORT |
|-------------------------------|--------------------|--------------------|--------------------|--------------------|
| CODE | 71507 | 71508 | 71509 | 71510 |
| GENERAL SPECIFICATIONS | | | | |
| Internal dimensions | 7 x 2,85 x 1,2 m | | | |
| External dimensions | 7,7 x 3,6 x 1,3 m | | | |
| Water capacity | 24 m ³ | | | |
| Empty weight / Full Weight | 2550 Kg - 26550 Kg | 3100 Kg - 27100 Kg | 3300 Kg - 27300 Kg | 2550 Kg - 26550 Kg |
| CHARACTERISTICS | | | | |
| Skimmers | - | - | - | - |
| Overflow suction | 2 | 2 | 2 | 2 |
| Return inlet | 3 | 4 | 4 | 3 |
| Bottom cleaner nozzles | 1 | 1 | 1 | 1 |
| Main drain | 2 | 2 | 2 | 2 |
| Projectors | 2 | 2 | 2 | 2 |
| ACCESSORIES | | | | |
| Ladder (3 steps) | ✓ | - | - | ✓ |
| Steps | - | ✓ | ✓ | - |
| Hydromassage bench | - | ✓ | ✓ | - |
| Hydromassage cascade | - | ✓ | ✓ | - |
| Hydromassage water jet | - | ✓ | ✓ | - |
| Hydromassage beds | - | - | ✓ | - |
| Countercurrent equipment | - | - | - | ✓ |
| Cover | - | ✓ | ✓ | - |
| RECOMMENDED EQUIPMENT | | | | |
| Hydraulic button and timer | - | 45218 + 35761 | 45218 + 35761 | - |
| Blower pump for hydro beds | - | - | 31091 | - |
| Blower pump for hydro bench | - | 35388 | 35388 | - |
| Filtration equipment | 23348 | | | |

Vitality pool made of stainless steel with overflow
9x3x1,2 m

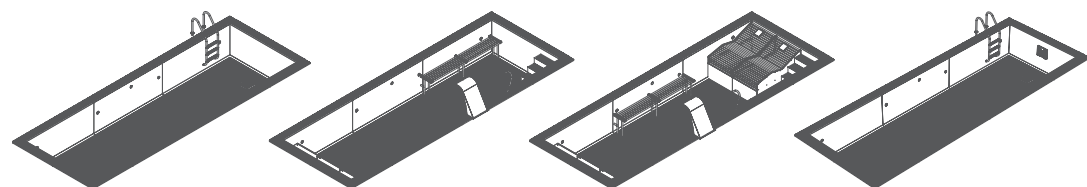

| MODEL | OPTIMAL | WELLNESS | COMFORT | SPORT |
|-------|---------|----------|---------|-------|
| CODE | 71514 | 71515 | 71516 | 71517 |

GENERAL SPECIFICATIONS

| | | | | |
|----------------------------|---------------------|--------------------|--------------------|--------------------|
| Internal dimensions | 8,84 x 2,85 x 1,2 m | | | |
| External dimensions | 9,6 x 3,6 x 1,3 m | | | |
| Water capacity | 31 m ³ | | | |
| Empty weight / Full Weight | 3050 Kg - 34050 Kg | 3500 Kg - 34500 Kg | 3700 Kg - 34700 Kg | 3050 Kg - 34050 Kg |

CHARACTERISTICS

| | | | | |
|------------------------|---|---|---|---|
| Skimmers | - | - | - | - |
| Overflow suction | 3 | 3 | 3 | 3 |
| Return inlet | 4 | 5 | 5 | 4 |
| Bottom cleaner nozzles | 1 | 1 | 1 | 1 |
| Main drain | 2 | 2 | 2 | 2 |
| Projectors | 2 | 2 | 2 | 2 |

ACCESSORIES

| | | | | |
|--------------------------|---|---|---|---|
| Ladder (3 steps) | ✓ | - | - | ✓ |
| Steps | - | ✓ | ✓ | - |
| Hydromassage bench | - | ✓ | ✓ | - |
| Hydromassage cascade | - | ✓ | ✓ | - |
| Hydromassage water jet | - | ✓ | ✓ | - |
| Hydromassage beds | - | - | ✓ | - |
| Countercurrent equipment | - | - | - | ✓ |
| Cover | - | ✓ | ✓ | - |

RECOMMENDED EQUIPMENT

| | | | | |
|-----------------------------|-------|---------------|---------------|---|
| Hydraulic button and timer | - | 45218 + 35761 | 45218 + 35761 | - |
| Blower pump for hydro beds | - | - | 31091 | - |
| Blower pump for hydro bench | - | 35388 | 35388 | - |
| Filtration equipment | 23349 | | | |

Vitality pool made of stainless steel with overflow
12x3x1,2 m

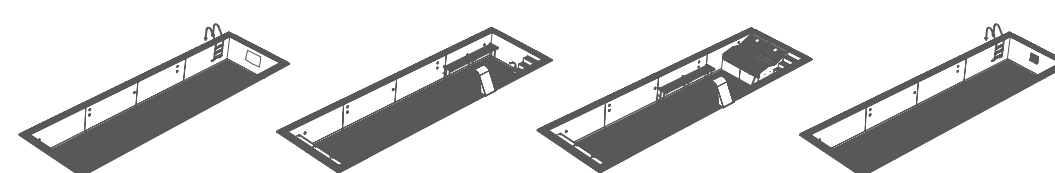

| MODEL | OPTIMAL | WELLNESS | COMFORT | SPORT |
|-------|---------|----------|---------|-------|
| CODE | 71521 | 71522 | 71523 | 71524 |

GENERAL SPECIFICATIONS

| | | | | |
|----------------------------|----------------------|--------------------|--------------------|--------------------|
| Internal dimensions | 11,84 x 2,85 x 1,2 m | | | |
| External dimensions | 12,6 x 3,6 x 1,3 m | | | |
| Water capacity | 41 m ³ | | | |
| Empty weight / Full Weight | 3850 Kg - 44850 Kg | 4350 Kg - 45350 Kg | 4500 Kg - 45500 Kg | 3850 Kg - 44850 Kg |

CHARACTERISTICS

| | | | | |
|------------------------|---|---|---|---|
| Skimmers | - | - | - | - |
| Overflow suction | 4 | 4 | 4 | 4 |
| Return inlet | 5 | 6 | 6 | 5 |
| Bottom cleaner nozzles | 2 | 2 | 2 | 2 |
| Main drain | 2 | 2 | 2 | 2 |
| Projectors | 3 | 3 | 3 | 3 |

ACCESSORIES

| | | | | |
|--------------------------|---|---|---|---|
| Ladder (3 steps) | ✓ | - | - | ✓ |
| Steps | - | ✓ | ✓ | - |
| Hydromassage bench | - | ✓ | ✓ | - |
| Hydromassage cascade | - | ✓ | ✓ | - |
| Hydromassage water jet | - | ✓ | ✓ | - |
| Hydromassage beds | - | - | ✓ | - |
| Countercurrent equipment | - | - | - | ✓ |
| Cover | - | ✓ | ✓ | - |

RECOMMENDED EQUIPMENT

| | | | | |
|-----------------------------|-------|---------------|---------------|---|
| Hydraulic button and timer | - | 45218 + 35761 | 45218 + 35761 | - |
| Blower pump for hydro beds | - | - | 31091 | - |
| Blower pump for hydro bench | - | 35388 | 35388 | - |
| Filtration equipment | 23350 | | | |

PLAYA / PLAYA LIVING

| CODE | MODEL | TOTAL DIMENSIONS (W X L X H) CM | WATER DIMENSIONS (W X L X H) CM | VOLUME (L) | PANEL COLOR | REF. LAGETTO |
|-------|----------------------------|---------------------------------|---------------------------------|------------|-------------|-------------------|
| 67338 | Playa 1 / Standard | 220x220x70 | 180x140x55 | 1200 | Coffee | KITDVPLA1BICF1G |
| 67339 | | | | | White | KITDVPLA1BIBI1G |
| 69349 | | | | | Grey | KITDVPLA1BIGR1G |
| 67340 | Playa 2 / Standard | 320x220x70 | 180x240x55 | 2000 | Coffee | KITDVPLA2BICF1G |
| 67341 | | | | | White | KITDVPLA2BIBI1G |
| 69351 | | | | | Grey | KITDVPLA2BIGR1G |
| 69355 | Playa 3 / Standard | 420x220x70 | 180x340x55 | 3000 | Coffee | KITDVPLA3BICF1G |
| 69356 | | | | | White | KITDVPLA3BIBI1G |
| 69358 | | | | | Grey | KITDVPLA3BIGR1G |
| 67342 | Playa 1 / Bubbles & Heater | 220x220x70 | 180x140x55 | 1200 | Coffee | KITDVPLARB1BICF1G |
| 67343 | | | | | White | KITDVPLARB1BIBI1G |
| 69352 | | | | | Grey | KITDVPLARB1BIGR1G |
| 67344 | Playa 2 / Bubbles & Heater | 320x220x70 | 180x240x55 | 2000 | Coffee | KITDVPLARB2BICF1G |
| 67345 | | | | | White | KITDVPLARB2BIBI1G |
| 69354 | | | | | Grey | KITDVPLARB2BIGR1G |
| 69361 | Playa 3 / Bubbles & Heater | 420x220x70 | 180x340x55 | 3000 | Coffee | KITDVPLARB3BICF1G |
| 69363 | | | | | White | KITDVPLARB3BIBI1G |
| 69364 | | | | | Grey | KITDVPLARB3BIGR1G |

DIMENSIONS

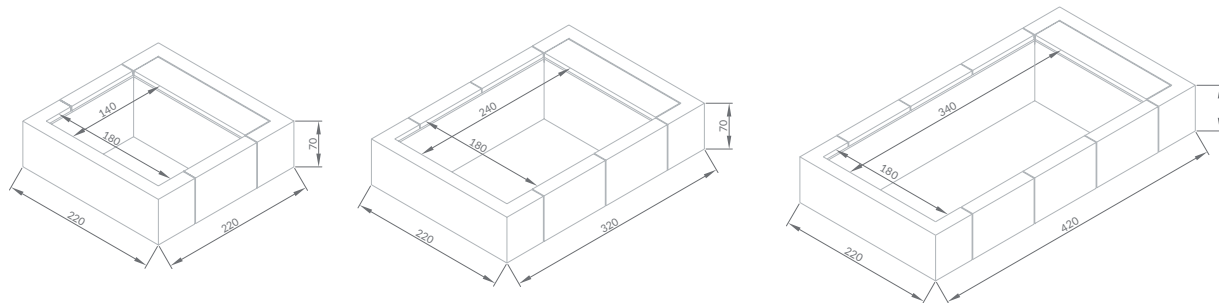

COMPLEMENTARY ACCESSORIES

Panels

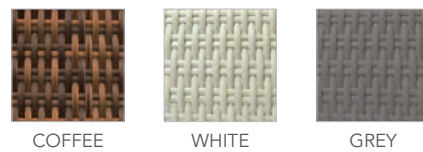

Upholstery (Living Option)



* See specific Playa Living codes in product sheet (sofa option)

Hydro Leisure Elements

WATER ZONE

POOL SURROUND CASCADE

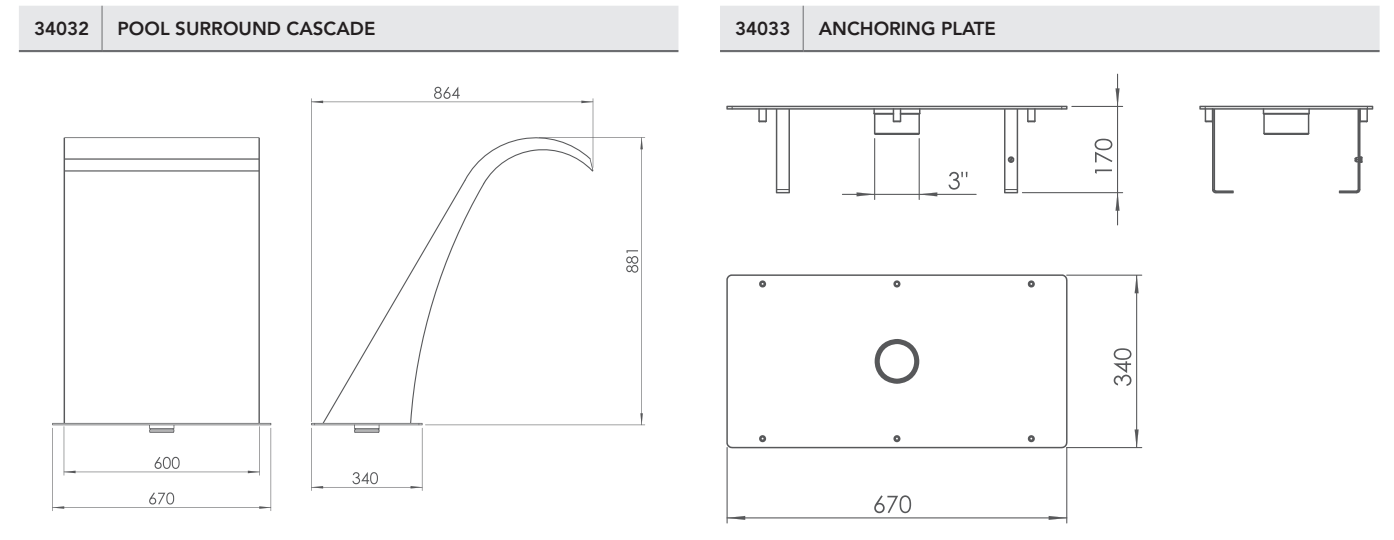

| 34032 | COMPLEMENTARY ACCESSORIES |
|-------------|---------------------------|
| 65570 | Recommended pump* |
| 30765 | Suction concrete |
| 45210 | Suction liner |
| 45219+35761 | Push button and timer |

* For a total water pressure head loss of 10 m.w.c.

POOL SURROUND WATER JET

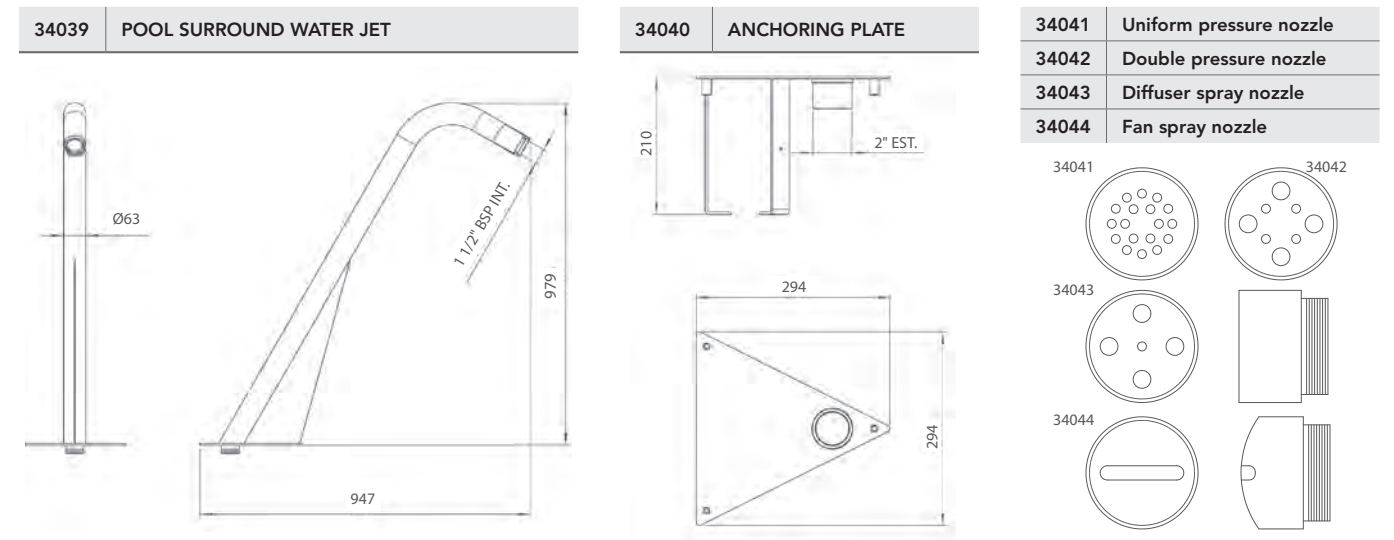

| 34039 | COMPLEMENTARY ACCESSORIES |
|-------------|---------------------------|
| 65570 | Recommended pump* |
| 30765 | Suction concrete |
| 45210 | Suction liner |
| 45219+35761 | Push button and timer |

* For a total water pressure head loss of 14 m.w.c.

Hydro Leisure Elements

WATER ZONE

WALL-MOUNTED WATER JET

34464 WALL-MOUNTED CIRCULAR WATER JET Ø84

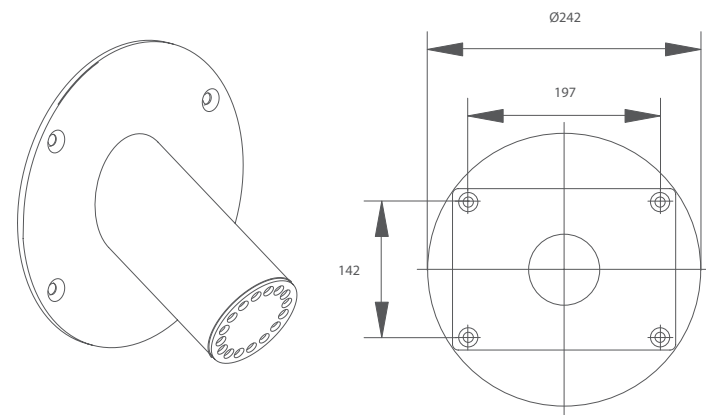

19983 RECTANGULAR CONCRETE POOL ANCHOR

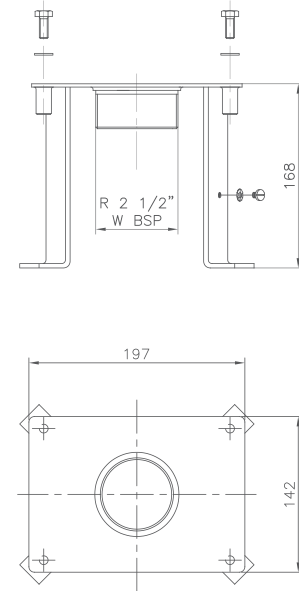

CERVICAL MASSAGE JET

60792 CERVICAL MASSAGE JET

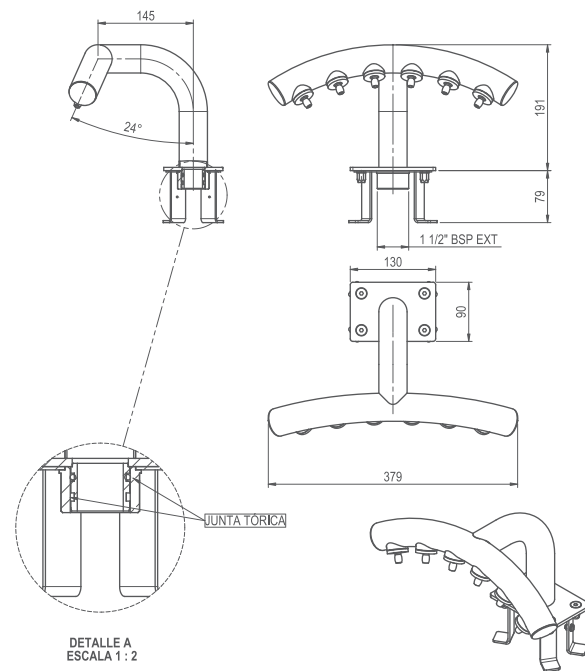

CERVICAL MASSAGE JET

| Water feature | Recommended pump* | Suction concrete | Suction liner | Push button and timer |
|---------------|-------------------|------------------|---------------|-----------------------|
| 60792 | 65558 | 19987 | 20091 | 45219 + 35761 |

* For a total water pressure head loss of 8 m.w.c.

MASSAGE NOZZLES

34049 3 MASSAGE NOZZLE KIT FOR CONCRETE

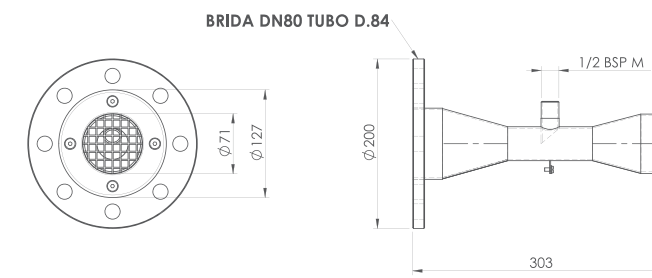

34050 HANDRAIL FOR MASSAGE NOZZLE SET

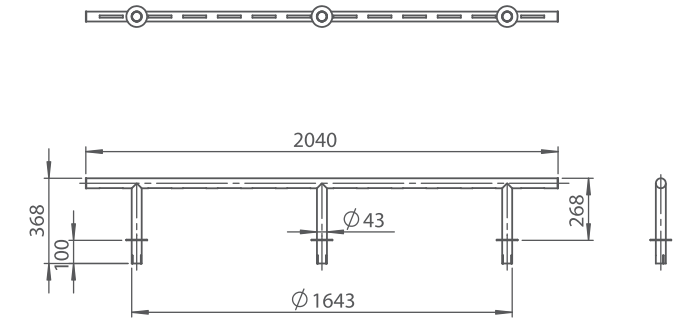

MASSAGE NOZZLES

| Water feature concrete | Water feature liner | Recommended pump* | Suction concrete | Push button and timer |
|------------------------|---------------------|-------------------|------------------|-----------------------|
| 34049 + 34050 | 40981 + 34050 | 08003 | 35368 | 45219 + 35761 |

* For a total water pressure head loss of 10 m.w.c.



HYDROMASSAGE JET

35753 9 NOZZLE TRIM AND JET SET CONCRETE

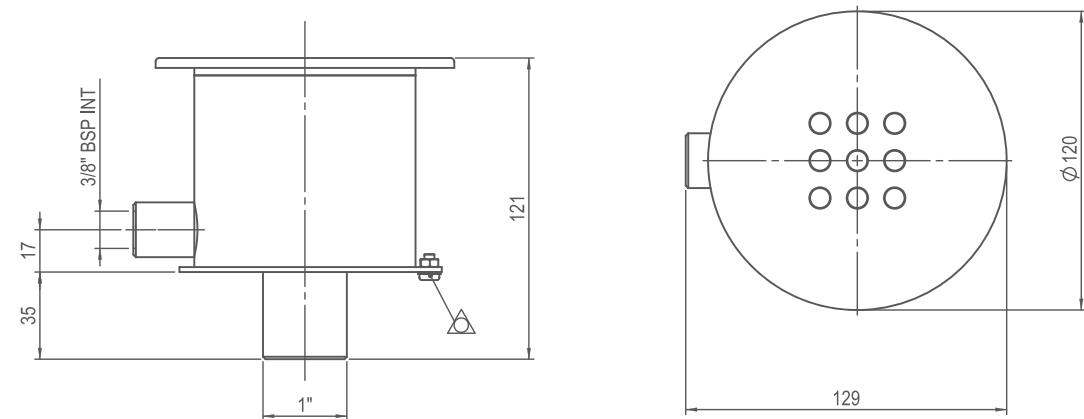

35754 BALL JET TRIM SET CONCRETE

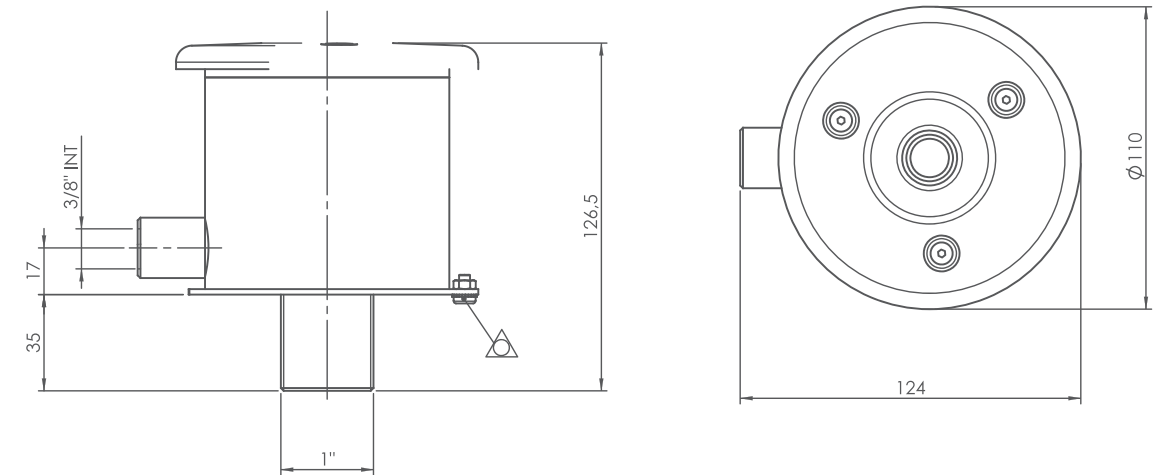

35753

| Pressure (m.c.a.) | Water flow (m³/h) | Observation |
|-------------------|-------------------|------------------------|
| 1 | 1 | |
| 2 | 1,6 | |
| 3 | 2,5 | Effect start |
| 4 | 3 | |
| 5 | 3,5 | Recommended water flow |
| 6 | 4 | |
| 7 | 4,25 | |
| 8 | 4,5 | |
| 9 | 4,75 | |
| 10 | 5 | |
| 11 | 5,5 | |

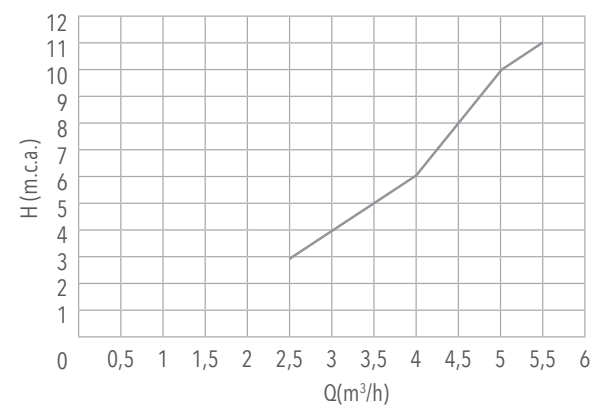

35754

| Pressure (m.c.a.) | Water flow (m³/h) | Observation |
|-------------------|-------------------|------------------------|
| 1 | 0,75 | |
| 2 | 1,6 | Effect start |
| 3 | 2,5 | |
| 4 | 3 | |
| 5 | 3,5 | Recommended water flow |
| 6 | 4 | |
| 7 | 4,25 | |
| 8 | 4,5 | |
| 9 | 4,75 | |
| 10 | 5 | |
| 11 | 5,5 | |

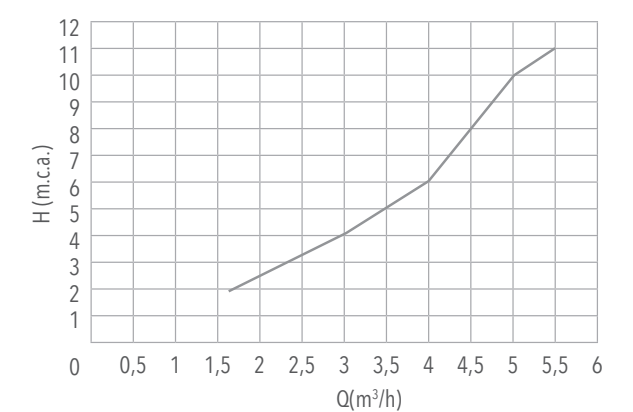

Hydro Leisure Elements

WATER ZONE

HYDROMASSAGE MINIJET

41282 9 NOZZLE TRIM AND MINIJET SET

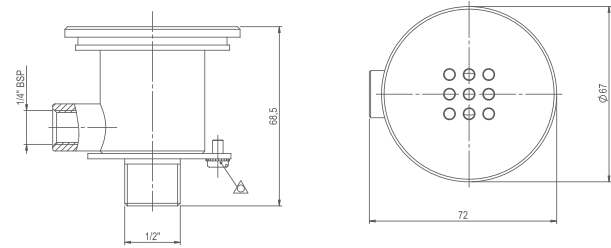

41283 BALL MINIJET TRIM SET

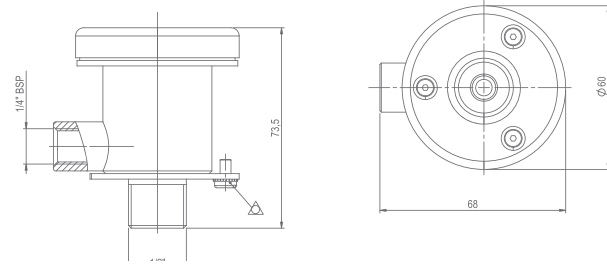

41283

| Pressure (m.c.a.) | Water flow (m³/h) | Observation |
|-------------------|-------------------|-------------|
| 10 | 1 | |
| 12 | 1,2 | |
| 14 | 1,3 | |
| 16 | 1,4 | |
| 18 | 1,5 | |
| 20 | 1,6 | |
| 22 | 1,65 | |
| 24 | 1,7 | |
| 26 | 1,8 | |
| 28 | 1,9 | |
| 30 | 2 | |

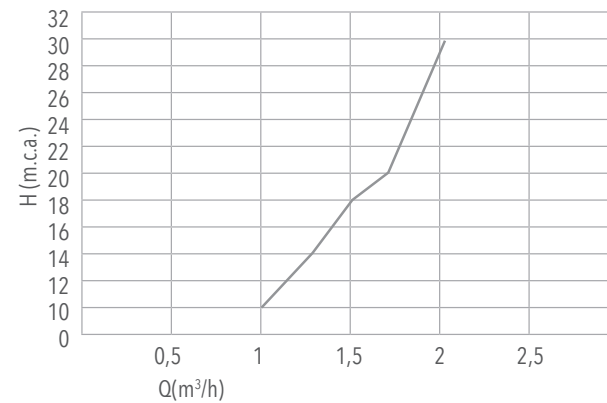

DYNAMIC HYDRO-CHANNEL JET

34055 DYNAMIC HYDRO-CHANNEL JET CONCRETE

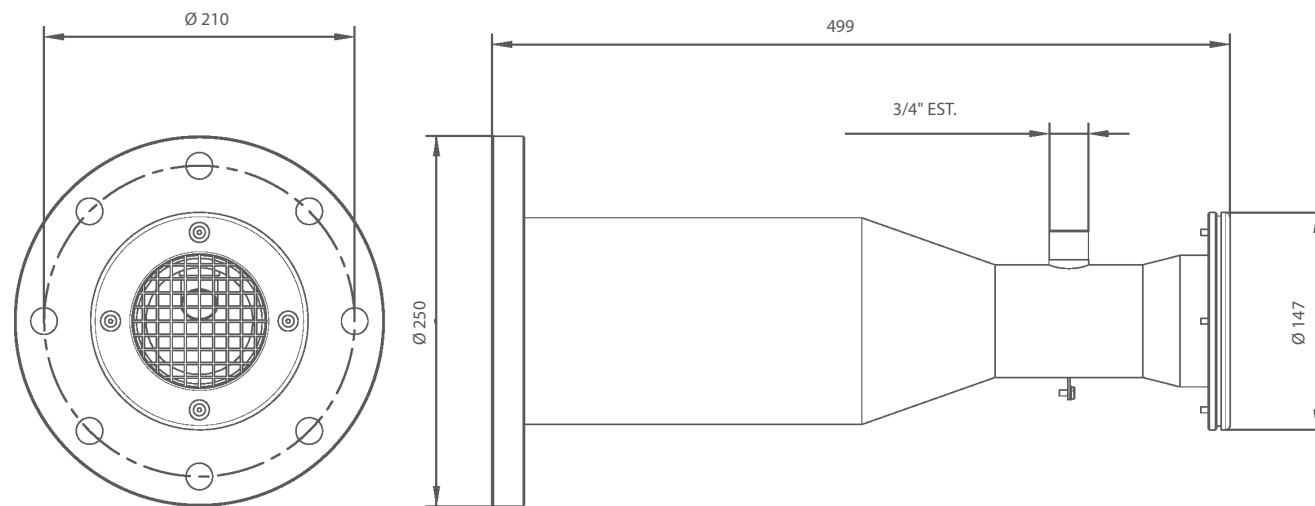

DYNAMIC HYDRO-CHANNEL JET CONCRETE

| Water feature concrete | Recommended pump* | Suction concrete | Suction liner | Push button and timer |
|------------------------|-------------------|------------------|---------------|-----------------------|
| 34055 | 08003 | 30765 | 45210 | 45219 + 35761 |

* For a total water pressure head loss of 10 m.w.c.

POOL FLOOR MASSAGE GRILLS

35078 300 mm DIAMETER HYDROMASSAGE GRILL CONCRETE

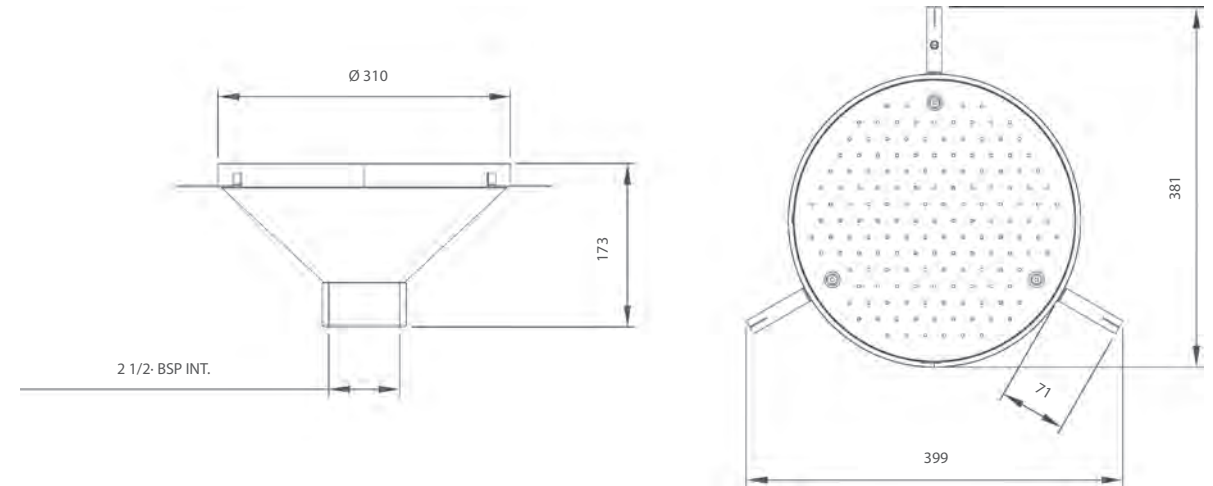

35077 HYDROMASSAGE GRILL 300 x 300 CONCRETE

35074 HYDROMASSAGE GRILL 500 x 500 CONCRETE

35075 HYDROMASSAGE GRILL 675 x 675 CONCRETE

35076 HYDROMASSAGE GRILL 750 x 750 CONCRETE

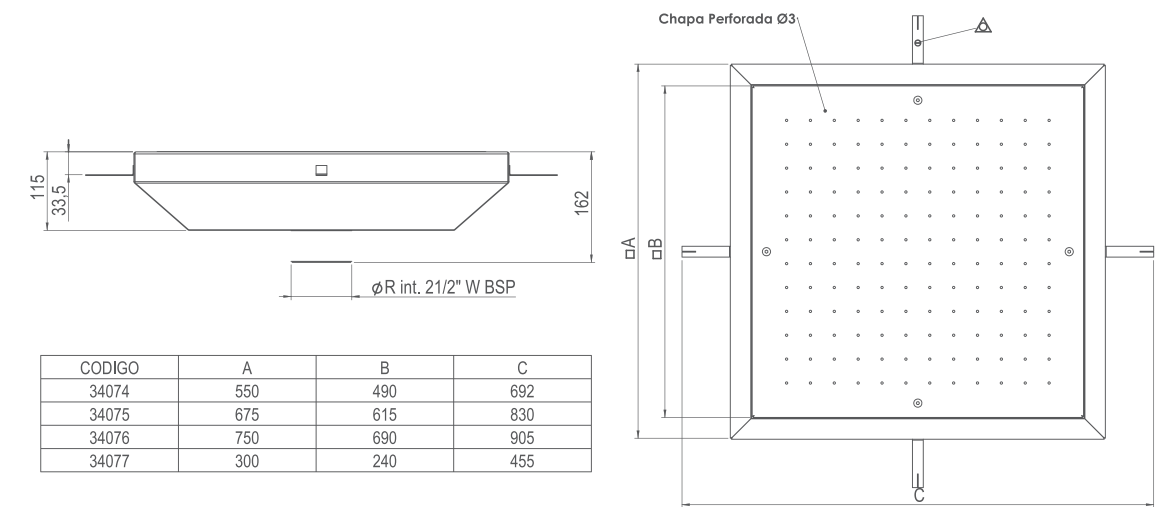

POOL FLOOR MASSAGE GRILLS

| Water feature concrete | Recommended air blower* | Push button and timer |
|------------------------|-------------------------|-----------------------|
| 35078 | 35388 | 45219 + 35761 |
| 35077 | 35388 | 45219 + 35761 |
| 35074 | 31091 | 45219 + 35761 |
| 35075 | 31091 | 45219 + 35761 |
| 35076 | 31091 | 45219 + 35761 |

* For a total pressure of 120 mbar.

Hydro Leisure Elements

WATER ZONE

BUBBLE SNAKE

| | |
|-------|---------------------------|
| 34048 | BUBBLE SNAKE FOR CONCRETE |
|-------|---------------------------|

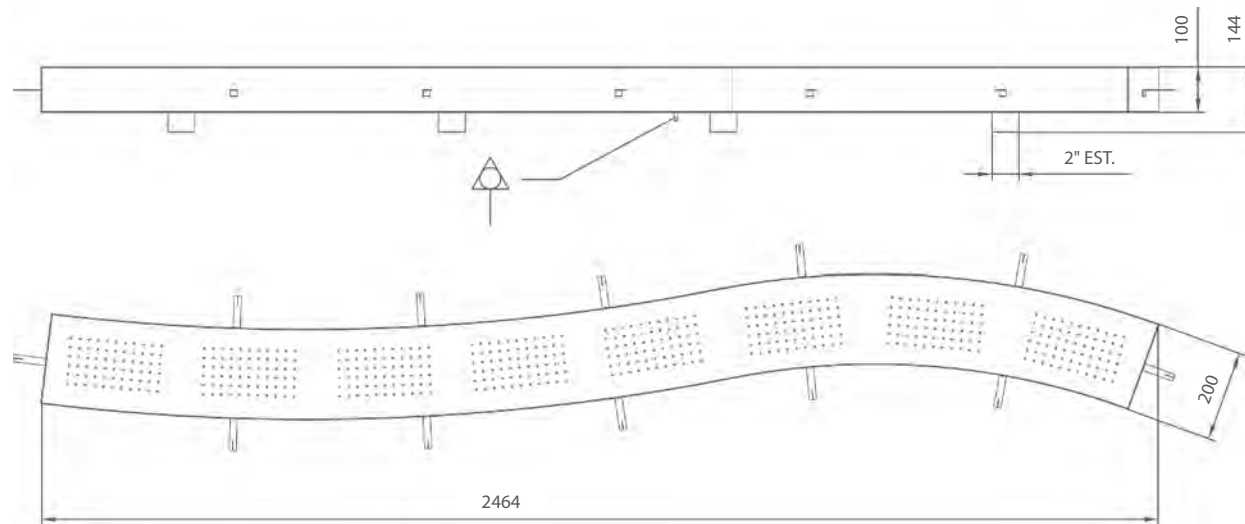

| BUBBLE SNAKE FOR CONCRETE | | | |
|---------------------------|---------------------|-------------------------|-----------------------|
| Water feature concrete | Water feature liner | Recommended air blower* | Push button and timer |
| 34048 | 40980 | 31092 | 45219 + 35761 |

* For a total pressure of 120 mbar.



HYDROMASSAGE BENCH

| | |
|-------|---------------------------|
| 60714 | 300 mm MODEL FOR CONCRETE |
| 68746 | 300 mm MODEL LINER |

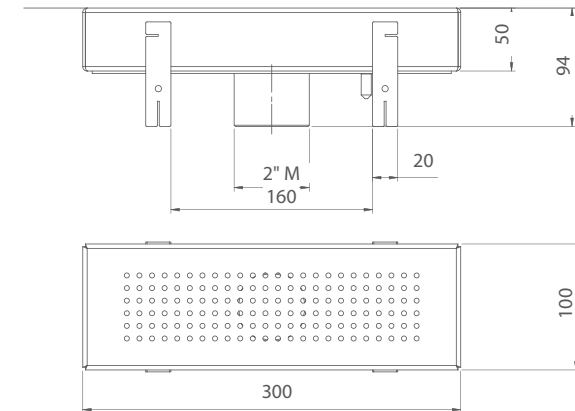

| | |
|-------|---------------------------|
| 34051 | 600 mm MODEL FOR CONCRETE |
|-------|---------------------------|

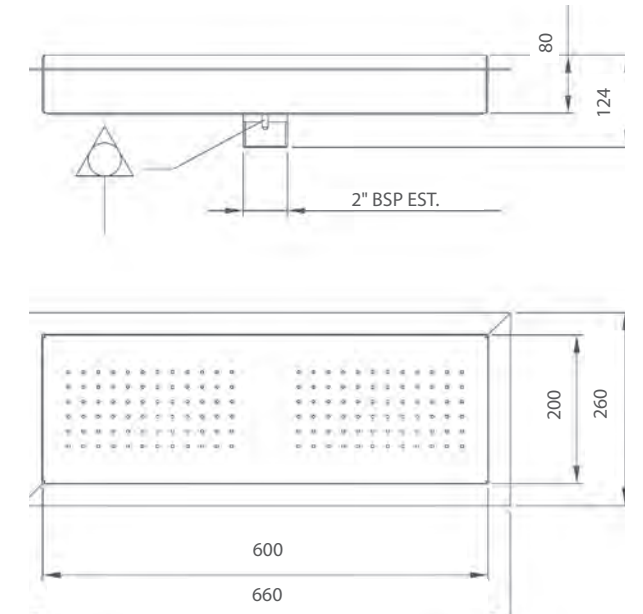

| | |
|-------|----------------------------|
| 34052 | 1200 mm MODEL FOR CONCRETE |
|-------|----------------------------|

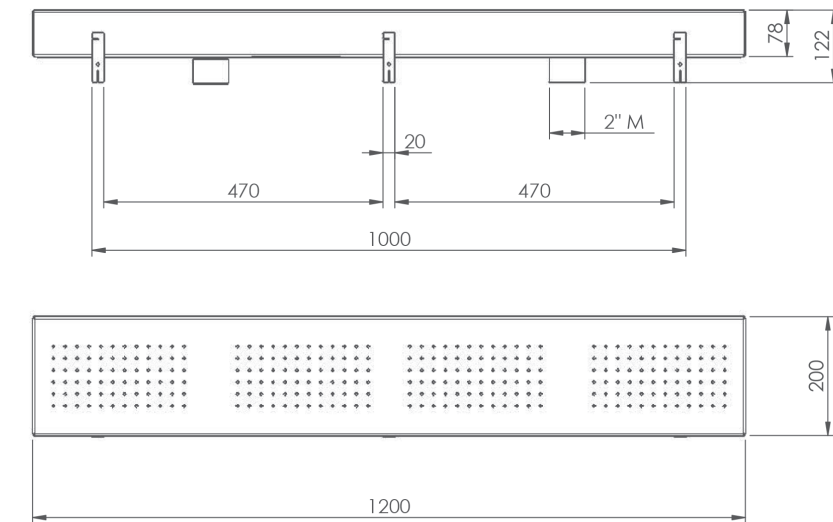

| HYDROMASSAGE BENCH | | | |
|------------------------|---------------------|-------------------------|-----------------------|
| Water feature concrete | Water feature liner | Recommended air blower* | Push button and timer |
| 34051 | A consultar | 35387 | 45219 + 35761 |
| 34052 | A consultar | 31091 | 45219 + 35761 |
| 60714 | 60746 | 35388 | 45219 + 35761 |

* For a total pressure of 100 mbar.

Hydro Leisure Elements

WATER ZONE

AIR BEDS

35249 SINGLE MODEL FOR CONCRETE

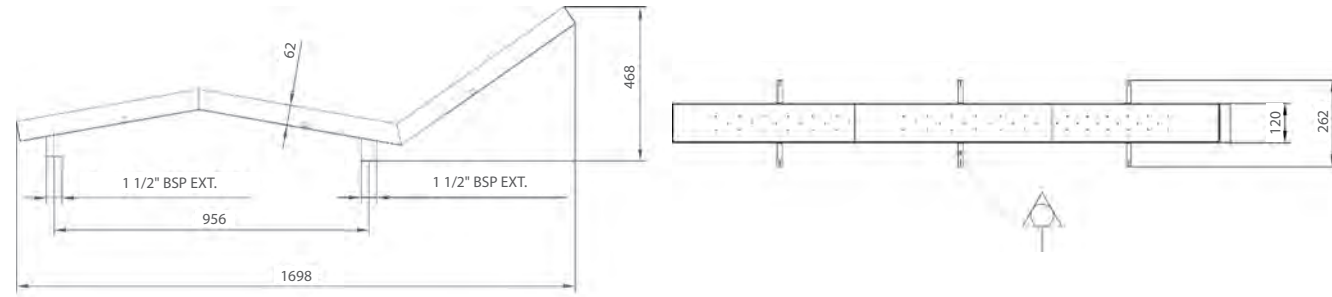

35250 DOUBLE MODEL CONCRETE

41159 DOUBLE MODEL LINER

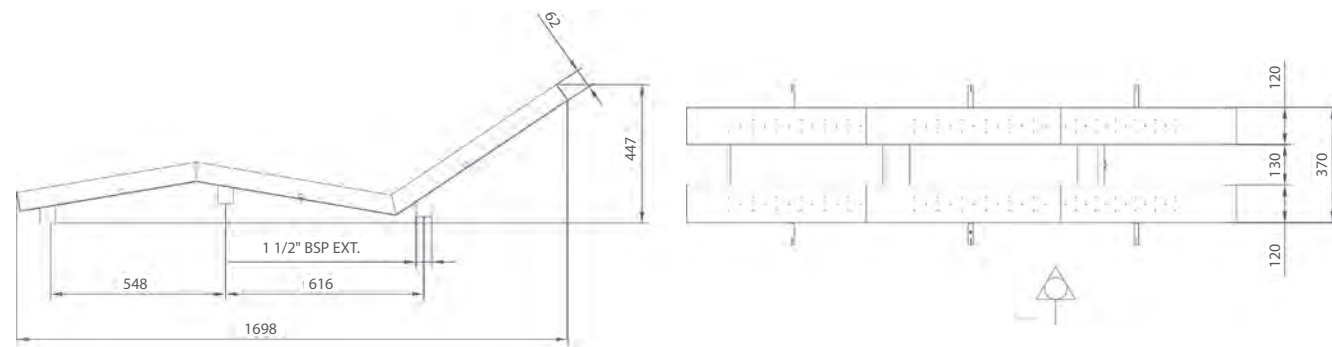

HYDROMASSAGE LOUNGER

31998 1700 mm EMBEDDED LOUNGER

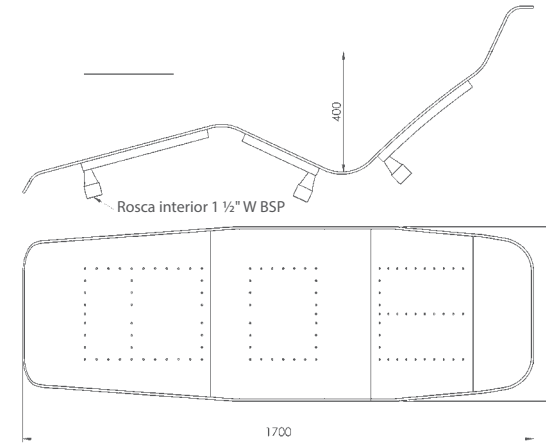

31996 1700 mm EMBEDDED COLUMN LOUNGER

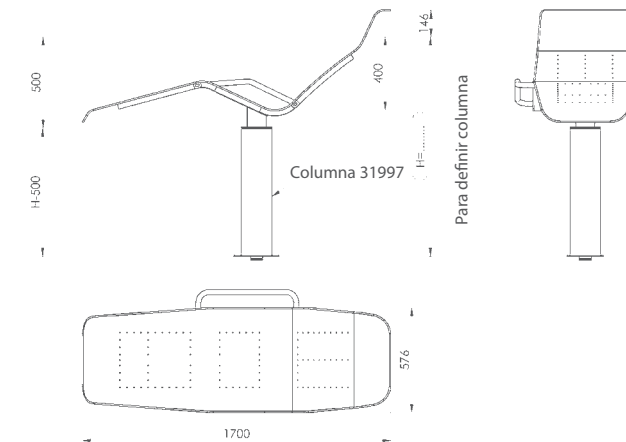

32070 1450 mm EMBEDDED COLUMN LOUNGE

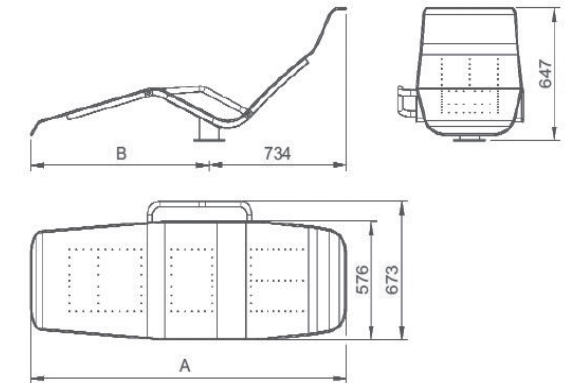

TO EMBED

| Water feature concrete | Water feature liner | Recommended air blower* | Push button and timer |
|------------------------|---------------------|-------------------------|-----------------------|
| 35249 | | 35388 | 45219 + 35761 |
| 35250 | 41159 | 31091 | 45219 + 35761 |

* For a total pressure of 100 mbar.

Hydro Leisure Elements

WATER ZONE

HYDROMASSAGE LOUNGER

| | |
|------------|-----------------------------|
| 31997L0500 | COLUMN FOR LOUNGER - 500 mm |
|------------|-----------------------------|

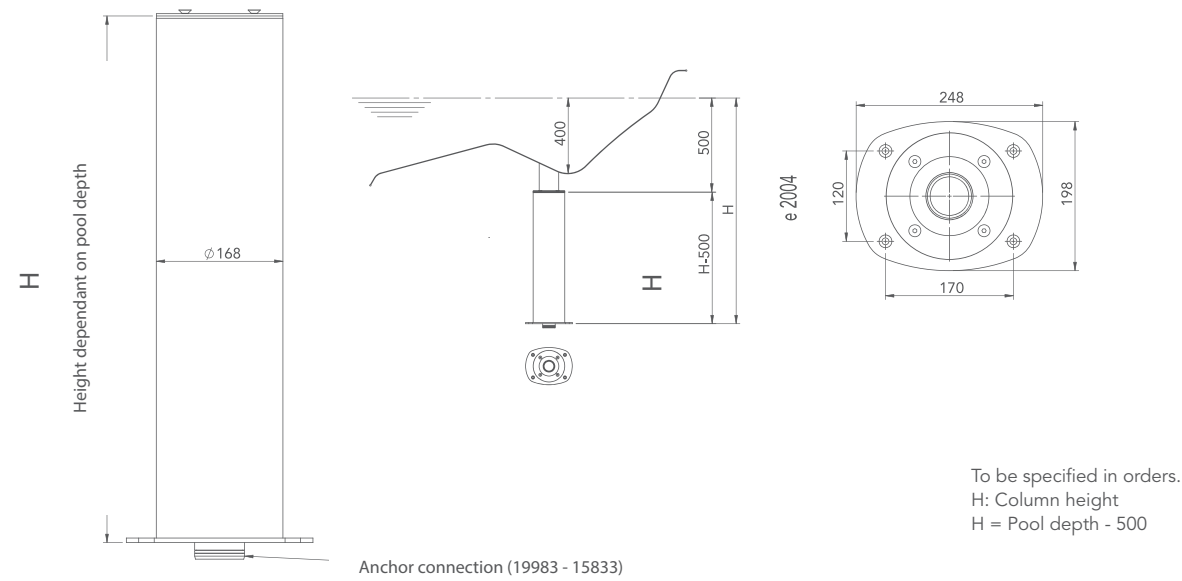

| | |
|-------|--------------------------------------|
| 19983 | RECTANGULAR ANCHOR FOR CONCRETE POOL |
|-------|--------------------------------------|

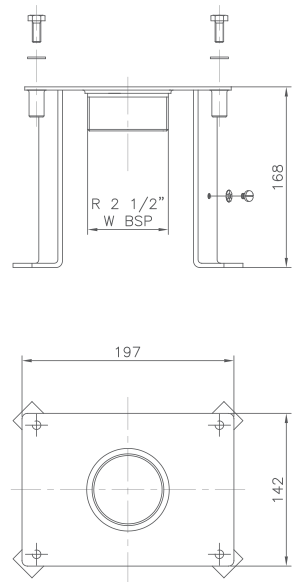

| | |
|-------|---|
| 15833 | RECTANGULAR ANCHOR FOR PREFABRICATED POOL |
|-------|---|

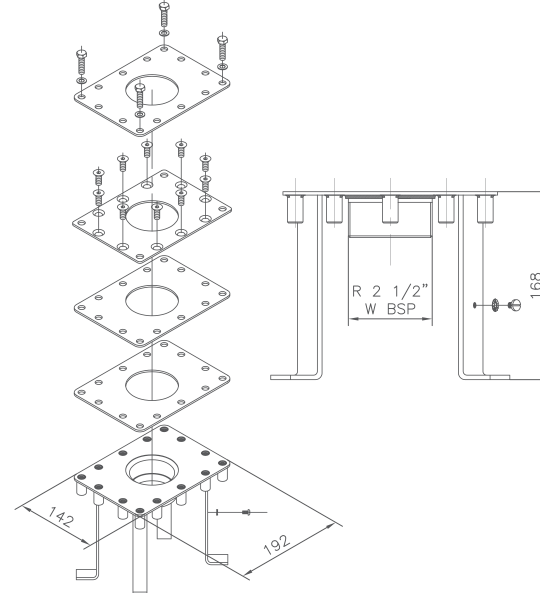

| TO EMBED | | | |
|------------------------|---------------------|-------------------------|-----------------------|
| Water feature concrete | Water feature liner | Recommended air blower* | Push button and timer |
| 31998 | | 31091 | 45219 + 35761 |
| 32071 | 41159 | 31091 | 45219 + 35761 |

| TO EMBED COLUMN | | | | | |
|-----------------|--------|--------------------|-----------------|-------------------------|-----------------------|
| Lounger | Column | Concrete anchoring | Liner anchoring | Recommended air blower* | Push button and timer |
| 31996 | 31997 | 19983 | 15833 | 31091 | 45219 + 35761 |

* For a total pressure of 100 mbar.

HYDROMASSAGE BEDS

| | |
|-------|-----------------------------------|
| 58812 | TUBULAR CONCRETE HYDROMASSAGE BED |
|-------|-----------------------------------|

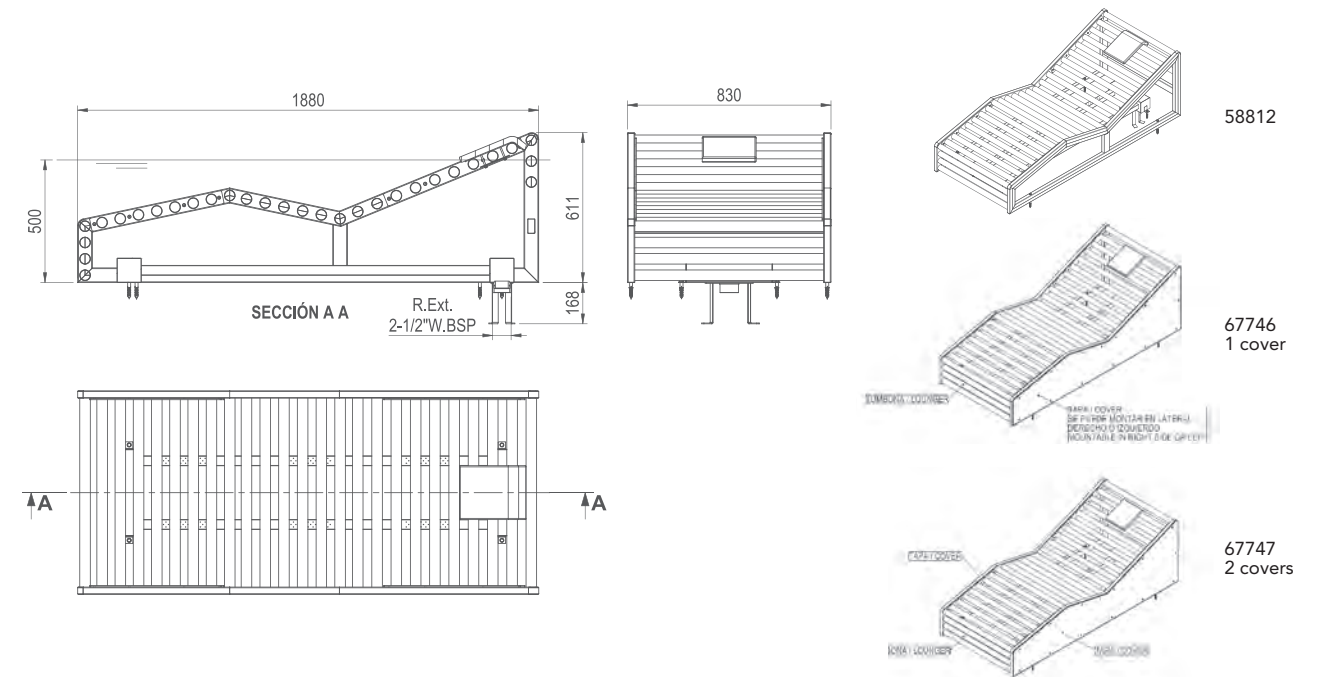

* Can be customised with logo.

| | |
|-------|---------------------------|
| 45665 | SPAECIAL HYDROMASSAGE BED |
|-------|---------------------------|

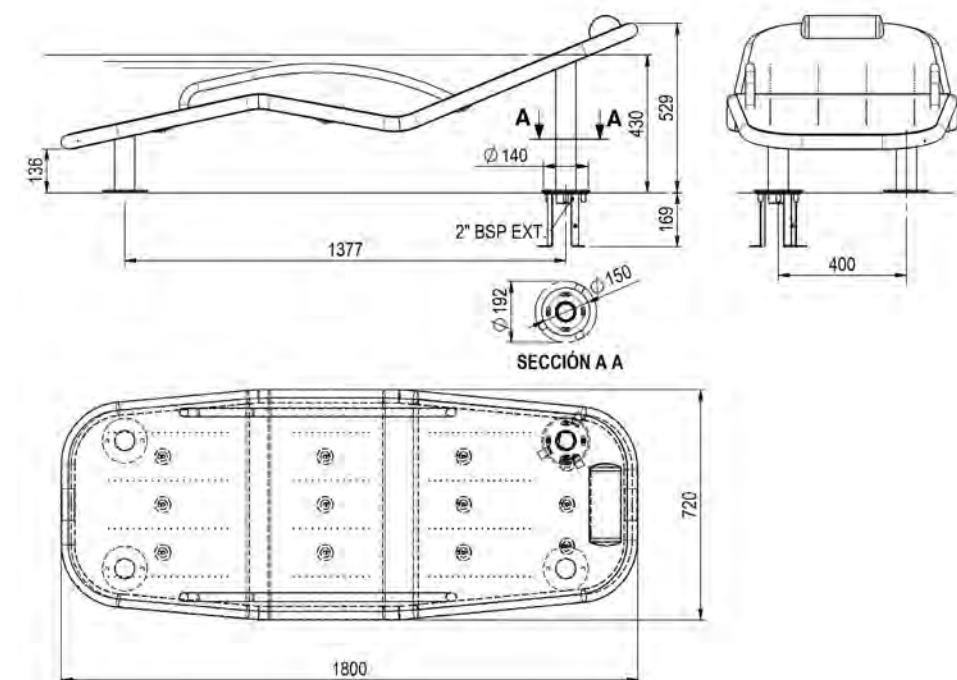

HIGH FLOW SUCTION GRILLS

58814 HIGH FLOW RATE SUCTION CABINET OF 120 M3/H FOR CONCRETE

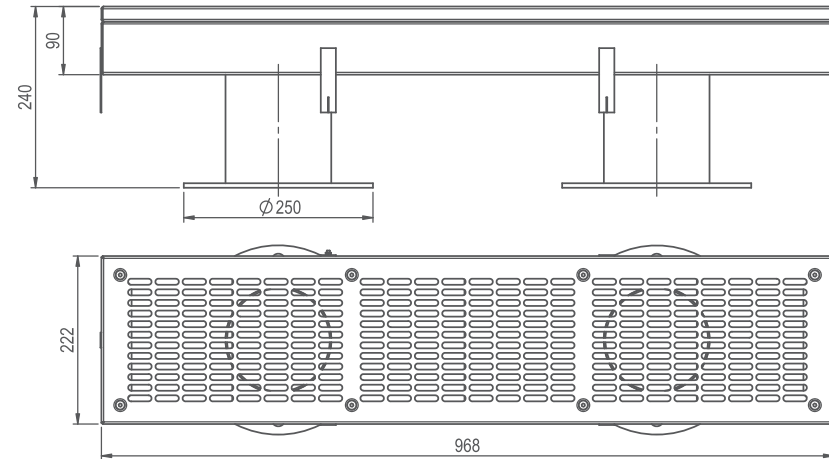

19983 RECTANGULAR ANCHOR FOR CONCRETE POOL

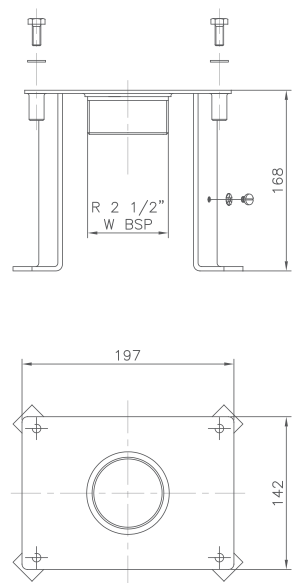

15833 RECTANGULAR ANCHOR FOR PREFABRICATED POOL

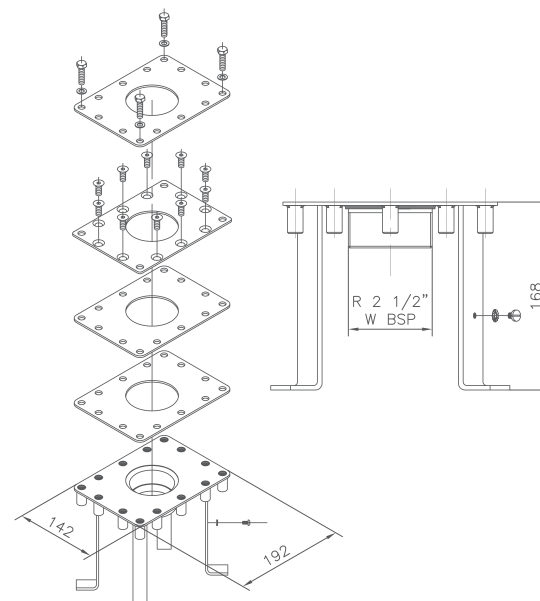

AIR BLOWERS

| CODE | Pump Power | FLOW | PRESSURE | VOLTAGE |
|----------|----------------------|------|----------|-------------|
| 35387-FG | 0,75 kW single phase | 144 | 190 | 110 / 220 V |
| 35388-FG | 0,75 kW 3 phase | 144 | 190 | 220 / 380 V |
| 31090-FG | 1,1 kW single phase | 216 | 180 | 220 V |
| 31091-FG | 1,3 kW 3 phase | 216 | 180 | 220 / 380V |
| 31092-FG | 1,75 kW 3 phase | 216 | 250 | 220 / 380 V |
| 35389-FG | 1,75 kW 3 phase | 156 | 320 | 220 / 380 V |
| 31093-FG | 2,2 kW 3 phase | 312 | 220 | 220 / 380 V |
| 31094-FG | 3,4 kW 3 phase | 222 | 410 | 220 / 380 V |
| 31095-FG | 3,4 kW 3 phase | 312 | 280 | 200 / 380 V |
| 31096-FG | 4 kW 3 phase | 312 | 280 | 200 / 380 V |
| 31097-FG | 5,5 kW 3 phase | 522 | 280 | 200 / 380 V |
| 31098-FG | 7,5 kW 3 phase | 522 | 360 | 380 / 660 V |
| 33970-FG | 0,4 kW 3 phase | | | |
| 33971-FG | 1,5 kW single phase | | | |
| 33972-FG | 5,5 kW 3 phase | | | |
| 33973-FG | 11 kW 3 phase | | | |

| SEKO | | COMPRESSION @ 50Hz - PRESSURE (mbar) / FLOW (m³/h) | | | | | | | | | | | | | | | | | | | | | | | | | | | |
|---------------|----------|--|------|-----|-----|-----|-----|-----|-----|-----|-----|-----|-----|-----|-----|-----|-----|-----|-----|-----|-----|-----|-----|-----|-----|-----|-----|-----|--|
| Model | | Conn. | kW | 0 | 50 | 75 | 100 | 125 | 150 | 175 | 200 | 225 | 250 | 275 | 300 | 325 | 350 | 375 | 400 | 425 | 450 | 475 | 500 | 525 | 550 | 600 | 625 | 650 | |
| BL02000100400 | 33970-FG | 1"1/4 | 0,4 | 80 | 58 | 45 | 33 | 12 | | | | | | | | | | | | | | | | | | | | | |
| BL04000100900 | 35387-FG | 1"1/2 | 0,85 | 140 | 112 | 100 | 90 | 70 | 55 | | | | | | | | | | | | | | | | | | | | |
| BL040001M0900 | 35388-FG | 1"1/2 | 0,85 | 140 | 112 | 100 | 90 | 70 | 55 | | | | | | | | | | | | | | | | | | | | |
| BL05000101300 | 31091-FG | 2" | 1,5 | 210 | 180 | 165 | 145 | 125 | 115 | | | | | | | | | | | | | | | | | | | | |
| BL050001M1300 | 31092-FG | 2" | 1,5 | 210 | 180 | 165 | 145 | 125 | 115 | | | | | | | | | | | | | | | | | | | | |
| BL05000101500 | 31090-FG | 2" | 1,5 | 210 | 180 | 165 | 145 | 125 | 115 | 90 | | | | | | | | | | | | | | | | | | | |
| BL050001M1500 | 33971-FG | 2" | 1,5 | 210 | 180 | 165 | 145 | 125 | 115 | 90 | | | | | | | | | | | | | | | | | | | |
| BL06000102200 | 31093-FG | 2" | 2,2 | 320 | 290 | 270 | 250 | 230 | 210 | 200 | 180 | | | | | | | | | | | | | | | | | | |
| BL06000103000 | 31095-FG | 2" | 3 | 320 | 290 | 270 | 250 | 230 | 210 | 200 | 180 | 165 | 140 | 120 | | | | | | | | | | | | | | | |
| BL07000105500 | 31097-FG | 2"1/2 | 5,5 | 520 | 490 | 470 | 430 | 410 | 395 | 380 | 355 | 330 | 305 | 290 | 255 | | | | | | | | | | | | | | |
| BL07000107500 | 31098-FG | 2"1/2 | 7,5 | 520 | 490 | 470 | 430 | 410 | 395 | 380 | 355 | 330 | 305 | 290 | 255 | 240 | 220 | 200 | 180 | 160 | 130 | | | | | | | | |
| BL42000201600 | 35389-FG | 1"1/2 | 1,6 | 150 | 135 | 130 | 125 | 120 | 115 | 100 | 95 | 90 | 85 | 75 | | | | | | | | | | | | | | | |
| BL52000203000 | 31094-FG | 2" | 3 | 230 | 220 | 210 | 195 | 185 | 175 | 170 | 165 | 155 | 145 | 135 | 125 | 120 | 110 | 100 | 85 | 80 | | | | | | | | | |
| BL52000204000 | 31096-FG | 2" | 4 | 230 | 220 | 210 | 195 | 185 | 175 | 170 | 165 | 155 | 145 | 135 | 125 | 120 | 110 | 100 | 85 | 80 | 70 | 60 | 50 | | | | | | |
| BL62000205500 | 33972-FG | 2" | 5,5 | 340 | 335 | 320 | 310 | 295 | 290 | 280 | 265 | 255 | 245 | 240 | 230 | 225 | 220 | 215 | 200 | 190 | 180 | 170 | 155 | 145 | | | | | |
| BL92000211000 | 33973-FG | 2"1/2 | 11 | 520 | 495 | 480 | 470 | 455 | 440 | 430 | 420 | 410 | 390 | 380 | 375 | 370 | 360 | 340 | 335 | 330 | 320 | 315 | 300 | 290 | 280 | 270 | | | |

AIR BLOWERS

DIMENSIONS

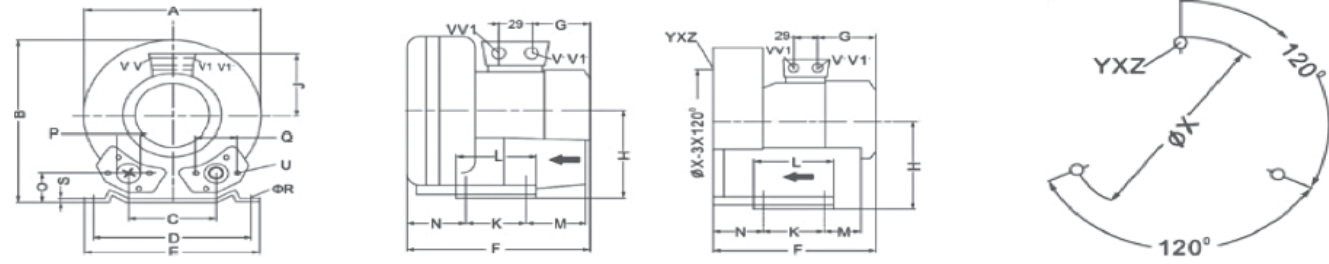

| | | | | | | | | | | | | | | | | (1~) | (3~) | | | | | | | | | | | | | | | | | | | | |
|----------|-----|-----|-----|----|-----|-----|-----|-----|---|----|-----|-----|-----|-----|-----|------|------|-----|---|----|-------|----|----|-----|----|-------|---------|---------|---|----|----|-----|-----|--------|--------------|--------------|---------|
| | A | A' | B | B' | C | C' | D | E | F | F' | F'' | G | H | H' | J | K | L | M | N | N' | O | P | P' | Q | ØR | S | T | U | V | V' | V1 | V1' | W | α | ØX | XYZ | holes X |
| 33970-FG | 246 | 247 | 90 | | 205 | 230 | 256 | | | | | 135 | 128 | 101 | 83 | 108 | 75 | 71 | | 39 | G1¼ | 64 | 10 | 3 | | M6x19 | | | | | | | | 140 | M6x15 | 0°/120°/240° | |
| 35387-FG | 286 | 302 | 115 | | 225 | 255 | 292 | | | | | 160 | 154 | 120 | 95 | 130 | 70 | 75 | | 46 | G1½ | 72 | 12 | 3 | | M6x19 | | | | | | | | 174 | M6x15 | 0°/120°/240° | |
| 35388-FG | 286 | 302 | 115 | | 225 | 255 | 294 | | | | | 160 | 154 | 120 | 95 | 130 | 70 | 75 | | 46 | G1½ | 72 | 12 | 3 | | M6x19 | M16x1.5 | M25X1.5 | | | | | | 174 | M6x15 | 0°/120°/240° | |
| 31091-FG | 334 | 337 | 120 | | 260 | 295 | 346 | | | | | 191 | 175 | 128 | 115 | 155 | 96 | 87 | | 48 | 55 | 83 | 14 | 4 | | M8x17 | | | | | | | 200 | M8x20 | 0°/120°/240° | | |
| 31092-FG | 334 | 337 | 120 | | 260 | 295 | 346 | | | | | 191 | 175 | 128 | 115 | 155 | 96 | 87 | | 48 | 55 | 83 | 14 | 4 | | M8x17 | | | | | | | 200 | M8x20 | 0°/120°/240° | | |
| 31090-FG | 334 | 337 | 120 | | 260 | 295 | 346 | | | | | 191 | 175 | 128 | 115 | 155 | 96 | 87 | | 48 | 55 | 83 | 14 | 4 | | M8x17 | | | | | | | 200 | M8x20 | 0°/120°/240° | | |
| 33971-FG | 334 | 337 | 120 | | 260 | 295 | 346 | | | | | 191 | 175 | 128 | 115 | 155 | 96 | 87 | | 48 | 55 | 83 | 14 | 4 | | M8x17 | | | | | | | 200 | M8x20 | 0°/120°/240° | | |
| 31093-FG | 382 | 384 | 125 | | 290 | 325 | 377 | | | | | 191 | 197 | 128 | 140 | 180 | 84 | 109 | | 54 | 55 | 83 | 15 | 4.5 | | M8x17 | | | | | | | 240 | M10x20 | 0°/120°/240° | | |
| 31095-FG | 382 | 384 | 125 | | 290 | 325 | 409 | | | | | 188 | 197 | 135 | 140 | 180 | 84 | 109 | | 54 | 55 | 83 | 15 | 4.5 | | M8x17 | | | | | | | 240 | M10x20 | 0°/120°/240° | | |
| 31097-FG | 451 | 461 | 152 | | 356 | 394 | 433 | 477 | | | | 230 | 240 | 148 | 170 | 217 | 140 | 124 | | 65 | 2"1/2 | 15 | 6 | | | | | | | | | | 286 | M12x20 | 0°/120°/240° | | |
| 31098-FG | 451 | 461 | 152 | | 356 | 394 | 433 | 477 | | | | 230 | 240 | 148 | 170 | 217 | 140 | 124 | | 65 | 2"1/3 | 15 | 6 | | | | | | | | | | 286 | M12x20 | 0°/120°/240° | | |

DIMENSIONS

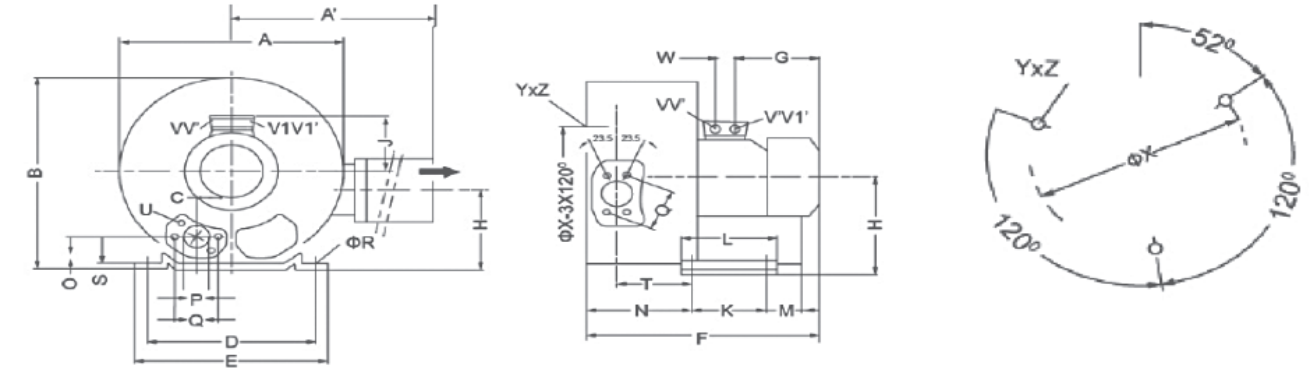

| | | | | | | | | | | | | | | | | (1~) | (3~) | | | | | | | | | | | | | | | | | | | | |
|----------|-----|-----|-----|-----|-----|----|-----|-----|-----|-----|-----|-----|-----|-----|-----|------|------|-----|-----|----|-----|-------|----|----|-----|-----|-------|---|---|----|----|-----|-----|--------|---------------------|---------------------|---------------------|
| | A | A' | B | B' | C | C' | D | E | F | F' | F'' | G | H | H' | J | K | L | M | N | N' | O | P | P' | Q | ØR | S | T | U | V | V' | V1 | V1' | W | α | ØX | XYZ | holes X |
| 35389-FG | 322 | 324 | 315 | | 58 | | 225 | 255 | 401 | | | 191 | 154 | 153 | 128 | 95 | 130 | 73 | 151 | | 45 | G1/2" | 72 | 12 | 3 | 104 | M6x19 | | | | | | | 28 | 174 | M6x15 | 51.5°/171.5°/291.5° |
| 31094-FG | 372 | 411 | 371 | | 60 | | 260 | 295 | 465 | | | 190 | 175 | 144 | 135 | 115 | 155 | 98 | 171 | | 48 | 55 | 83 | 14 | 4 | 116 | M8x17 | | | | | | 42 | 200 | M8x20 | 51.5°/171.5°/291.5° | |
| 31096-FG | 372 | 411 | 371 | | 60 | | 260 | 295 | 499 | | | 224 | 175 | 144 | 135 | 115 | 155 | 98 | 171 | | 48 | 55 | 83 | 14 | 4 | 116 | M8x17 | | | | | | 42 | 200 | M8x20 | 51.5°/171.5°/291.5° | |
| 33972-FG | 426 | 426 | 410 | | 154 | | 290 | 325 | 571 | | | 226 | 197 | 162 | 167 | 140 | 180 | 200 | 205 | | 53 | G2 | 83 | 15 | 4.5 | 130 | M8x17 | | | | | | 42 | 240 | M10x20 | 51.5°/171.5°/291.5° | |
| 33973-FG | 500 | 549 | 490 | 509 | 76 | | 356 | 394 | 694 | 717 | | 318 | 240 | 199 | 197 | 170 | 217 | | 212 | 84 | 105 | G2½ | 15 | 6 | | | | | | | | 42 | 286 | M12x20 | 51.5°/171.5°/291.5° | | |

AIR BLOWERS CURVE DETAILS

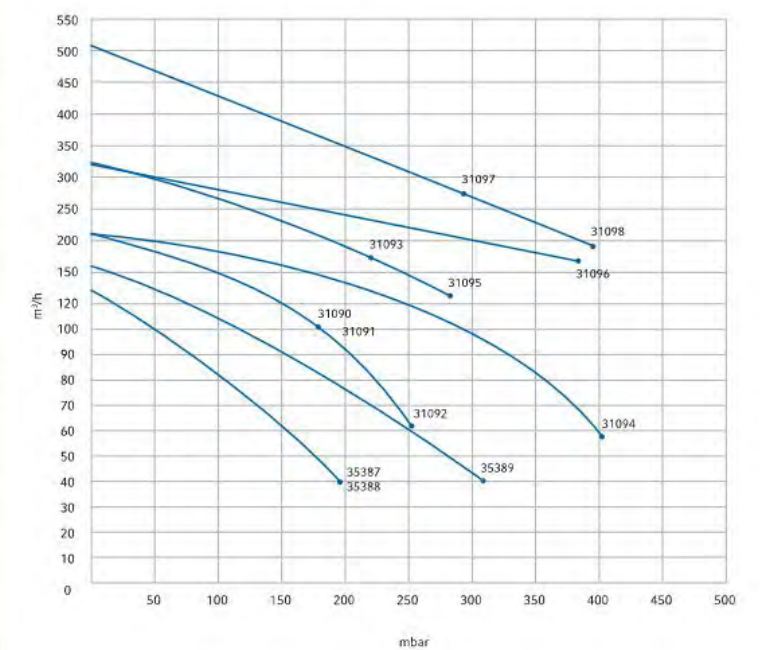
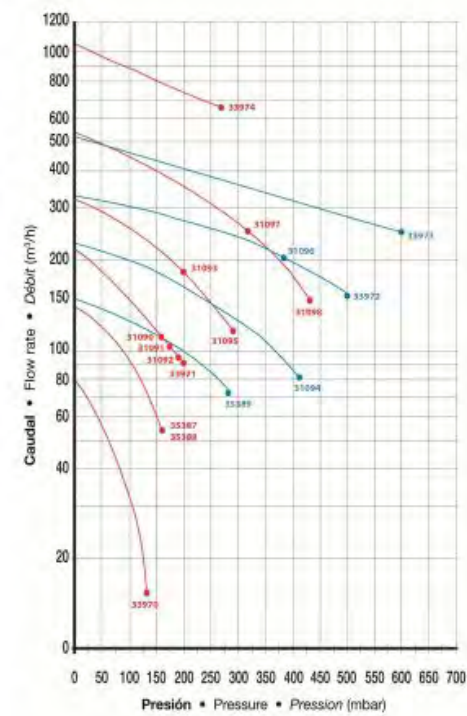

PIEZOELECTRONIC PUSH BUTTON KIT

| | |
|-------|----------------------------------|
| 45219 | SINGLE PIEZOELECTRIC PUSH BUTTON |
| 35759 | 1 LED PUSH BUTTON |
| 35760 | 2 LEDS PUSH BUTTON |

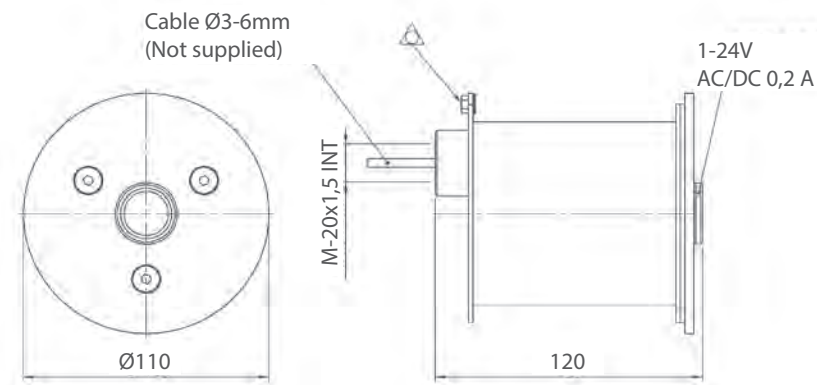

ELECTRIC DIAGRAM

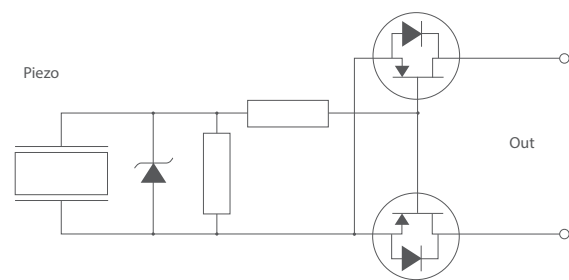

INSTALLATION

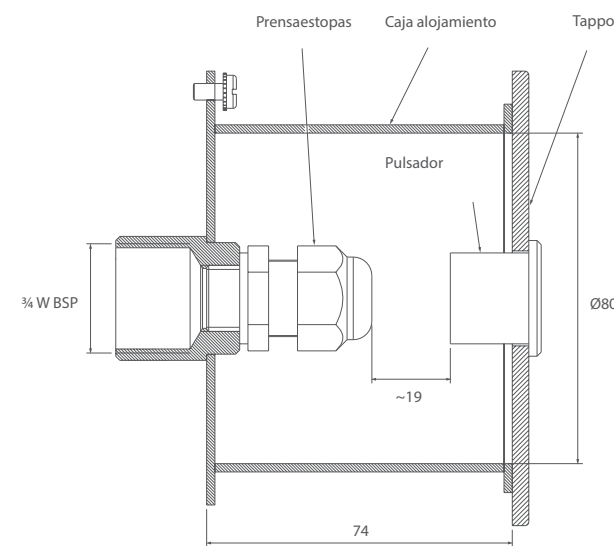

SINGLE PIEZOELECTRIC PUSH BUTTON

- Housing: stainless steel
- Connection: RED PVC WIRES 24 AWG
- Switching voltage: 1 - 24 V AC/DC
- Switching current: 0,200 A
- Switch resistance "on": <math><20\Omega</math>
- Switch resistance "off": >math>>5\Omega</math>
- Actuation force: 3-5N
- Make impulse time: 125-300 mSEC
- Operating and storage temp: -40 °C to 125 °C

60747 SINGLE PIEZOELECTRIC PUSH BUTTON

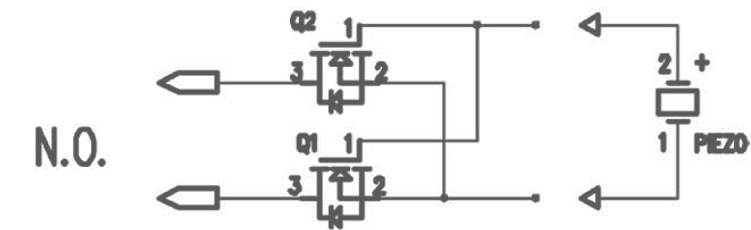

WATER EFFECT TIMER

- Voltage: 220 V AC - 50 Hz.
- Maximum relay current: - 50 Hz 12 A.
- Contact type NC/NA.
- LED voltage outlet: red and green, independently.
- Timer dimensions 52 x 90 x 80 mm
- Times available: 1,2,3,4,5,6,7,8,10,12,15,20,25 and 30 minutes.
- LED indications:
 - LEDs off = no voltage.
 - Permanent green LED: relay circuit activated.
 - Permanent red LED: relay circuit deactivated.
 - Flashing green LED: 10 seconds to shut off.

Regulations:

- Directive 2014/35/EU, on electrical equipment designed for use within certain voltage limits
- Directive 2014/30/EU, on electromagnetic compatibility
- Directive 2011/65/EU, on the restriction of the use of certain hazardous substances in electrical and electronic equipment
- Directive 2009/125/EC on the framework for setting ecodesign requirements for energy-related products

35403 WATER EFFECT TIMER

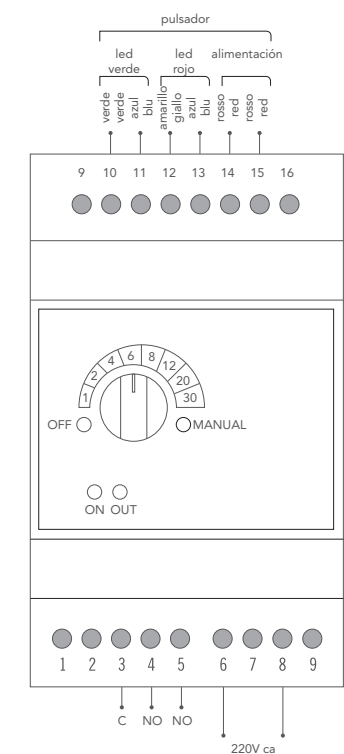

Stainless steel Spas

W A T E R Z O N E

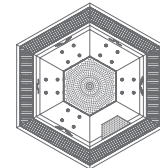
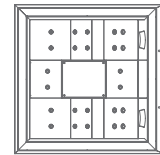
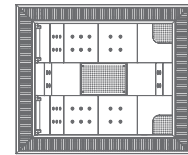
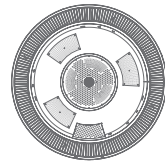

| MODEL | VULCANO SPA | MERCURIO SPA | VENUS SPA | NEPTUNO SPA |
|-------|-------------|--------------|-----------|-------------|
| CODES | 71469 | 71470 | 71471 | 71473 |

GENERAL SPECIFICATIONS

| | | | | |
|-----------------------------|--------------------|----------------------|----------------------|----------------------|
| Internal dimensions | Ø1,73 x 0,81 m | 2,10 x 1,70 x 0,80 m | 1,68 x 1,53 x 0,70 m | 1,86 x 1,61 x 0,90 m |
| External dimensions | Ø2,30 x 0,90 m | 2,70 x 2,30 x 0,90 m | 2,11 x 2,11 x 0,90 m | 2,54 x 2,20 x 1,00 m |
| Positions (seats /loungers) | 6 (6 / -) | 4 (2 / 2) | 4 (2 / 2) | 5 (5 / -) |
| Water capacity | 1,5 m ³ | 2 m ³ | 1,23 m ³ | 1,2 m ³ |
| Empty weight / Full Weight | 400 - 1900 kg | 900 - 2900 kg | 325 - 1560 kg | 400 / 1600 kg |

CHARACTERISTICS

| | | | | |
|-----------------------------|----------|----------|----------|----------|
| Num. Massage Jets (water) | 12 | 12 | 20 | 23 |
| Num. Nozzles (air) | 18 | 32 | 16 | 20 |
| Overflow / Skimmer | Overflow | Overflow | Overflow | Overflow |
| Overflow aspiration | 4 | 4 | 8 | 6 |
| Return inlet | 2 | 2 | 1 | 2 |
| Pool floor inlet | 1 | 1 | No | 1 |
| Main drain | 1 | 1 | 1 | 1 |
| Headrests | No | Yes | Yes | No |
| LED Lights | 3 | 2 | 4 | 3 |
| Piezoelectronic push button | 2 | 2 | 2 | 2 |

OPTIONS (NOT INCLUDED)

| | | | | |
|--------------------------------|----------|----------|----------|----------|
| Stainless steel Overflow grill | Optional | Optional | Optional | Optional |
| Wood Overflow grill | Optional | Optional | Optional | Optional |
| Cover | Optional | Optional | Optional | Optional |

RECOMMENDED EXT. EQUIPMENT

| | | | | |
|------------------------|-------|-------|-------|-------|
| Compact filtration kit | 05135 | 05135 | 05135 | 16412 |
| Compensation tank | Yes | Yes | Yes | Yes |

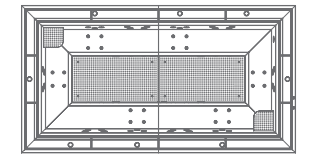
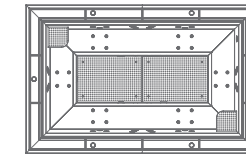
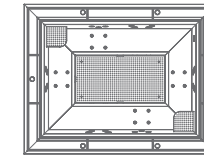
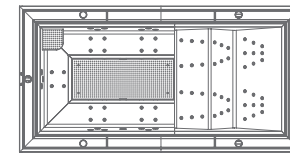

| ZEUS SPA | APOLO 6 SPA | APOLO 8 SPA | APOLO 10 SPA |
|----------|-------------|-------------|--------------|
| 71474 | 71475 | 71476 | 71477 |

| | | | |
|----------------------|----------------------|----------------------|----------------------|
| 3,48 x 1,51 x 0,94 m | 2,24 x 1,62 x 0,98 m | 2,88 x 1,62 x 0,98 m | 3,52 x 1,62 x 0,98 m |
| 4,21 x 2,10 x 1,04 m | 2,84 x 2,21 x 1,18 m | 3,47 x 2,21 x 1,18 m | 4,11 x 2,21 x 1,18 m |
| 7 (5 / 2) | 6 (6 / -) | 8 (8 / -) | 10 (10 / -) |
| 2,65 m ³ | 2,40 m ³ | 3,20 m ³ | 4,00 m ³ |
| 650 / 3300 kg | 550 / 2950 kg | 700 / 3900 kg | 720 / 4720 kg |

| | | | |
|------------|----------|----------|----------|
| 25 | 34 | 40 | 56 |
| 62 | 16 | 24 | 24 |
| Overflow | Overflow | Overflow | Overflow |
| 6 | 6 | 6 | 8 |
| 3 | 2 | 4 | 4 |
| 1 | 1 | 1 | 1 |
| 1 | 1 | 2 | 2 |
| On request | No | No | No |
| 2 | 2 | 2 | 4 |
| 3 | 2 | 2 | 2 |

| | | | |
|----------|----------|----------|----------|
| Yes | Optional | Optional | Optional |
| Optional | Optional | Optional | Optional |
| Optional | Optional | Optional | Optional |

| | | | |
|------------|-------|-------|-------|
| On request | 16412 | 43639 | 43639 |
| Yes | Yes | Yes | Yes |

Stainless steel Spas

W A T E R Z O N E

Optional Kits for spas



| MODEL | KIT 50 | KIT 75 | KIT 75 2M | KIT 75 3M |
|-------|--------|--------|-----------|-----------|
| CODE | 04015 | 05135 | 16412 | 43639 |

GENERAL SPECIFICATIONS

| | | | | |
|----------------------------------|---------------|---------------|---------------|----------------------|
| Filter | Ø 500 | Ø 650 | Ø 650 | Ø 650 |
| Filtration pump | 0,60 Kw | 0,82 Kw | 0,82 Kw | 0,82 Kw |
| Massage pump (P1) | 1,4 Kw | 1,4 Kw | 2 x 1,81 Kw | 2 x 1,81 Kw + 2,7 Kw |
| Blower pump | 1,3 Kw | 1,3 Kw | 1,3 Kw | 1,3 Kw |
| Electric heat | 6 Kw | 6 Kw | 6 Kw | 6 Kw |
| Ozonator | Optional | Optional | Optional | Yes |
| Dosific. auto + pH y Cl. control | Optional | Optional | - | - |
| Water-water exchanger 20 kW | Optional | Optional | Optional | Optional |
| Push buttons / Control | Piezoelectric | Piezoelectric | Piezoelectric | Piezoelectric |
| Required power Low AMP (W) | 9,362 W | 9,582 W | 11,802 W | 14,485 W |
| Required power (A) | 18,1 A | 19,2 A | 23 A | 27,5 A |
| Voltage | 400 V III + N | 400 V III + N | 400 V III + N | 400 V III + N |

Grills and optional accessories



| MODEL | PLASTIC GRILL | STAINLESS STEEL GRILL | WOODEN GRILL | IPE WOODEN GRILL |
|-------|---------------|-----------------------|--------------|------------------|
| CODE | 05581 - 05582 | 32415 - 32416 | On request | On request |



| MODEL | CASCADE | PROJECTOR | HYDROMASSAGE BENCH | HYDROMASSAGE BED | COVERS |
|-------|---------|-----------|--------------------|------------------|--------|
| CODE | 20130 | 52242 | 71498 | 71497 | - |

Acrylic Spas

W A T E R Z O N E



| MODEL | ODISEA 20 | MIRAGE 40 | ROMA | TOKYO 70 |
|-------|-----------|-----------|-------|----------|
| CODES | 45709 | 75546 | 40769 | 53990 |

GENERAL SPECIFICATIONS

| | | | | |
|-----------------------------|--|-----------|---|---|
| Dimensions (± 1cm) | Ø 230 | Ø 250 | Ø 300 | 340 x 240 |
| Positions (seats /loungers) | 5 (5 / -) | 6 (6 / -) | 9 (9 / -) | 7 (6 / 1) |
| Water capacity | 1.120 l | 1.410 l | 2.290 l | 2.200 l |
| Empty weight | 163 kg | 353 kg | 310 kg | 502 kg |
| Full Weight | 1.283 kg | 1.763 kg | 2.600 kg | 2.702 kg |
| Color external finishes | 44-White / 59-Sterling / 72-Perla Cameo / 64-Pearl Shadow / 46-Blue Marble | A02 / A72 | 44-White / 59-Sterling / 46-Blue Marble | 44-White / 46-Blue Marble / 59-Sterling |

CHARACTERISTICS

| | | | | |
|------------------------------|----------------|-----------|----------------|-----------|
| Massage Jets | 8 | 26 | 18 | 58 |
| Air injectors | 10 | 12 | 18 | 21 |
| Color jets | White | Inox | White | Inox |
| Headrests | - | - | - | 2 |
| Cascade | - | - | - | Optional |
| Projector | Optional | Yes | Yes | Yes |
| Chromotherapy LED lights | Optional 1 LED | Yes 1 LED | Optional 1 LED | 4 LED |
| Galvanized metal structure | Yes | Yes | Yes | Yes |
| Isothermal cover | Optional | Optional | Optional | Optional |
| Piezoelectronic push buttons | 2 | 2 | 2 | 3 |
| Compact Kit | Kit 50/75 | Kit 75 2M | Kit 75 2M | Kit 75 3M |

COMPENSATION TANK

| | | | | |
|-------------------|----------|----------|----------|----------|
| Compensation tank | 1.000 l. | 1.000 l. | 2.000 l. | 2.000 l. |
|-------------------|----------|----------|----------|----------|

SPA FILTRATION EQUIPMENT

| | | | | |
|-----------------------------|------------------|------------------|------------------|------------------|
| Filter | Ø 500 | Ø 650 | Ø 650 | Ø 650 |
| Filtration pump | 0,60 Kw | 0,82 Kw | 0,82 Kw | 0,82 Kw |
| Massage pump (P1) | 1,4 Kw | 2 x 1,81 Kw | 2 x 1,81 Kw | 2 x 1,81Kw+2,7Kw |
| Blower pump | 1,3 Kw | 1,3 Kw | 1,3 Kw | 1,3 Kw |
| Electric heat | 6 Kw | 6 Kw | 6 Kw | 6 Kw |
| Ozonator | Optional | Optional | Optional | Optional |
| Water-water exchanger 20 kW | Optional | Optional | Optional | Optional |
| Push buttons / Control | Piezoelectronics | Piezoelectronics | Piezoelectronics | Piezoelectronics |
| Required power Low AMP (W) | 9.362 W | 11.802 W | 11.802 W | 14.485 W |
| Required power (A) | 18,1 A | 23 A | 23 A | 27,5 A |
| Voltage | 400 V III + N | 400 V III + N | 400 V III + N | 400 V III + N |



| VERONA | OLYMPIA | COLISEUM |
|--------|---------|----------|
| 70550 | 26440 | 20141 |

| | | |
|--|---|--|
| 228 x 228 | 379 x 249 | Ø 297 |
| 5 (3 / 2) | 11 (11 / -) | 10 (10 / -) |
| 1.200 l | 2,490 l | 1.944 l |
| 147 kg | 373 kg | 224 kg |
| 1.347 kg | 2,863 kg | 2.168 kg |
| 44-White / 59-Sterling / 72-Perla Cameo / 64-Pearl Shadow / 46-Blue Marble | 44-White / 46-Blue Marble / 59-Sterling | 44-White / 59-Sterling / 72-Perla Cameo / 64-Pearl Shadow / 46-Blue Marble |

| | | |
|----------------|----------------|----------------|
| 24 | 16 | 16 |
| 12 | 20 | 18 |
| White | White | White |
| - | - | - |
| - | - | - |
| Yes | Optional | Optional |
| Optional 1 LED | Optional 1 LED | Optional 1 LED |
| Yes | Yes | Yes |
| Optional | Optional | Optional |
| 2 | 2 | 2 |
| Kit 75 2M | Kit 75 2M | Kit 75 2M |

| | | |
|----------|----------|----------|
| 1.000 l. | 2.000 l. | 1.000 l. |
|----------|----------|----------|

| | | |
|------------------|------------------|------------------|
| 16412 | 16412 | 16412 |
| Ø 650 | Ø 650 | Ø 650 |
| 0,82 Kw | 0,82 Kw | 0,82 Kw |
| 2 x 1,81 Kw | 2 x 1,81 Kw | 2 x 1,81 Kw |
| 1,3 Kw | 1,3 Kw | 1,3 Kw |
| 6 Kw | 6 Kw | 6 Kw |
| Optional | Optional | Optional |
| Optional | Optional | Optional |
| Piezoelectronics | Piezoelectronics | Piezoelectronics |
| 11.802 W | 11.802 W | 11.802 W |
| 23 A | 23 A | 23 A |
| 400 V III + N | 400 V III + N | 400 V III + N |

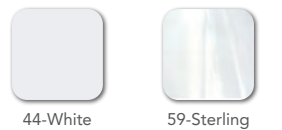

44-White 59-Sterling



72-Cameo Pearl 64-Pearl Shadow



46-Blue Marble



A02 A72



A02 A72

Nordic Bath

W A T E R Z O N E

WOODEN BATH

The baths are crafted in the finest red cedar (grade 2, 40 mm thick) for maximum durability. They are available in different diameters (150 cm to 220 cm) to accommodate 2 to 8 people (not including filtering equipment).

| CODE | DESCRIPTION | SEATS |
|-------|--------------------------|------------|
| 74095 | Wooden nordic bath 150cm | 2/3 people |
| 74096 | Wooden nordic bath 160cm | 3/4 people |
| 74109 | Wooden nordic bath 180cm | 5/6 people |
| 74110 | Wooden nordic bath 200cm | 6/7 people |
| 74111 | Wooden nordic bath 220cm | 7/8 people |

STAINLESS STEEL BATH

The baths are crafted in the finest red cedar (grade 2, 40 mm thick) for maximum durability. They are available in different diameters (150 cm to 220 cm) to accommodate 2 to 8 people (not including filtering equipment).

| CODE | DESCRIPTION | SEATS |
|-------|-----------------------------------|------------|
| 74112 | Stainless Steel nordic bath 150cm | 2/3 people |
| 74113 | Stainless Steel nordic bath 160cm | 3/4 people |
| 74114 | Stainless Steel nordic bath 180cm | 5/6 people |
| 74115 | Stainless Steel nordic bath 200cm | 6/7 people |
| 74116 | Stainless Steel nordic bath 220cm | 7/8 people |

WATER TREATMENT FOR NORDIC BATH

AstralPool's Nordic baths offer a unique filtration and treatment technology that guarantees bacteria-free water.

- Ultra-fine 1-micron filtration captures 100% of particles.
- Pump powerful enough to completely renew water every 6 minutes.
- Ultraviolet radiation treatment together with an ozone treatment effectively eliminates bacteria.
- The OZONE CHOC® treatment cleans the biofilms and removes the bacteria inside the bath (international patent EP2785648)
- Water quality measurement and management are handled by an integrated computer (ORP reader, pH, T° C).

| CODE | DESCRIPTION | PUMP | OZONE GENERATOR | UV | HEATER | PH/ORP MANAGEMENT | SMARTPHONE APP |
|-------|--------------------------------------|-----------------------------------|-----------------|--------|------------|-------------------|----------------|
| 74117 | Water treatment nordic bath standard | 550w | 1 lamp | 1 lamp | 3kw | - | - |
| 74118 | Water treatment nordic bath PRO | 550w | 2 lamps | 1 lamp | 3kw | Yes | - |
| 74119 | Water treatment nordic bath PRO+ | 750w with integrated heater 1,5wh | 3 lamps | 1 lamp | 3kw + 3 kw | Yes | Yes |





Technical Characteristics

Chrysalis

RELAX ZONE

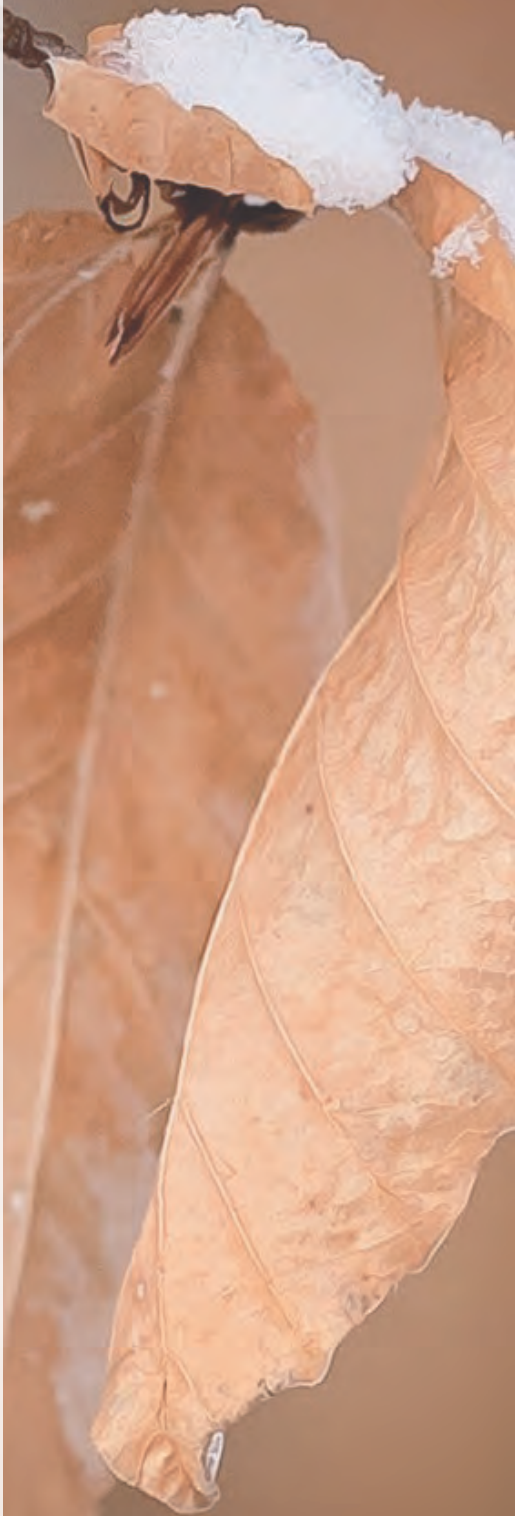

Coated relax loungers

R E L A X Z O N E

CLASSIC LOUNGER

The Lounger kit assembly contains:

- Top of the lounger.
- Base of the lounger.
- Installation auxiliary material: Adhesive fiberglass tape 10 cm x 45 m (1 unit), mortar joint treatment MALLOR MJ-73 5 kg (1 un.), and MALLOR AR-99 Reactive Adhesive 6 kg (1 un.)

| | |
|-------|--|
| 67749 | CLASSIC LOUNGER WITH STRAIGHT-EDGED BASE WITHOUT HEATING SHEET |
| 67750 | CLASSIC LOUNGER WITH STRAIGHT-EDGED BASE WITH HEATING SHEET |
| 67751 | CLASSIC LOUNGER WITH ROUNDED-EDGED BASE WITHOUT HEATING SHEET |
| 67753 | CLASSIC LOUNGER WITH ROUNDED-EDGED BASE WITH HEATING SHEET |

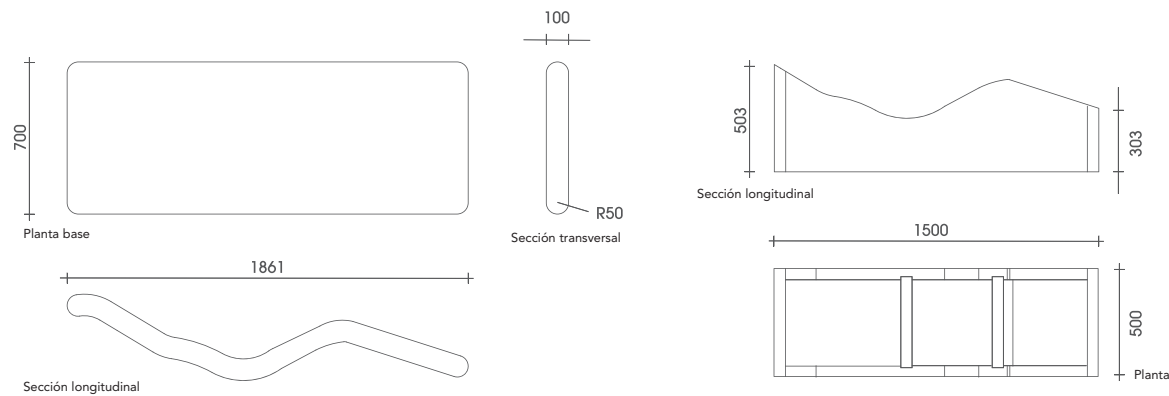

Area to be tiled:

- Lounger base with Straight/Rounded edges: 1.5 m²
- Lounger (top component): 2.5 m² (the area just above the base that cannot be seen does not need tiling)

Technical specifications

- Core: high density rigid expanded polystyrene core
- (EPS), CFC and HCFC free and fire retardant additive incorporated, in accordance with EN 13163.

Lounger installation kit included

RETRO LOUNGER

| | |
|-------|-------------------------------|
| 67754 | RETRO LOUNGER WITHOUT HEATING |
|-------|-------------------------------|

The Lounger Kit Assembly contains:

- Base of the lounger.
- Top of the lounger.
- Installation auxiliary material: Adhesive fiberglass tape 10cm x 45m (1 unit), mortar joint treatment MJ-73 5 kg (1 un.), and AR-99 Reactive Adhesive 6 kg (1 un.)..

| | |
|-------|---------------------------------------|
| 67755 | RETRO LOUNGER WITH ELECTRICAL HEATING |
|-------|---------------------------------------|

The Lounger Kit Assembly contains:

- Top of the lounger with heating sheet integrated of 220 W/m²..
- Base of the lounger.

Installation auxiliary material: Adhesive fiberglass tape 10 cm x 45 m (1 unit), mortar joint treatment MJ-73 5 kg (1 un.), and AR-99 Reactive Adhesive 6 kg (1 un.)

- 220V to 24V Transformer, to be located in separate room, to wet zone can only pass 24V.

- Thermostat and temperature probe

| | |
|------------|--|
| DIMENSIONS | |
|------------|--|

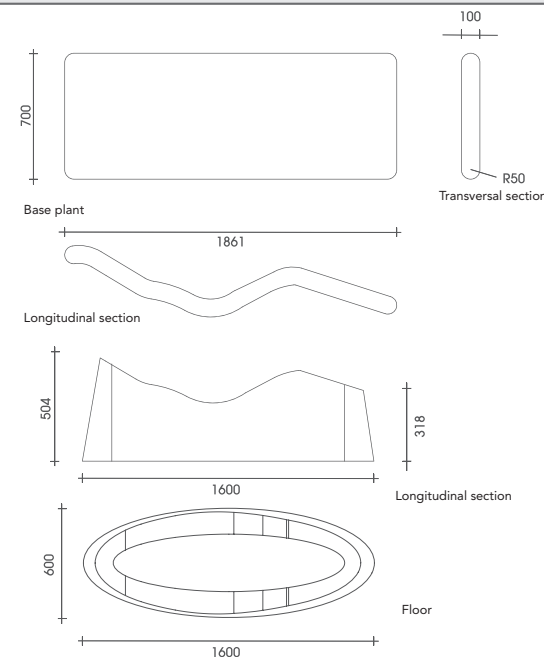

* Lounger supplied without tiles.

LUXOR LOUNGER

| | |
|-------|-------------------------------|
| 67756 | LUXOR LOUNGER WITHOUT HEATING |
|-------|-------------------------------|

The Lounger Kit Assembly contains:

- Lounger Pool
- Installation auxiliary material: Adhesive fiberglass tape 10 cm x 45 m (1 unit), mortar joint treatment MJ-73 5 kg (1 un.), mortar IMPER 2K 8 kg (1 un.) and AR-99 Reactive Adhesive 6 kg (1 un.)..

Area to be tiled: 2,95 m²

- Lounger base with Straight/Rounded edges: 1.5 m²
- Oval base: 1.3 m²
- Lounger (top component): 2.4 m² (the area just above the base that cannot be seen does not need tiling)

| | |
|-------|---------------------------------------|
| 67757 | LUXOR LOUNGER WITH ELECTRICAL HEATING |
|-------|---------------------------------------|

The Lounger Kit Assembly contains:

- Lounger Pool with heating sheet integrated of 220 W/m².
- Installation auxiliary material: Adhesive fiberglass tape 10 cm x 45 m (1 unit), mortar joint treatment MJ-73 5 kg (1 un.), mortar IMPER 2K 8 kg (1 un.) and AR-99 Reactive Adhesive 6 kg (1 un.)..
- 220V to 24V Transformer, to be located in separate room, to wet zone can only pass 24V.

| | |
|------------|--|
| DIMENSIONS | |
|------------|--|

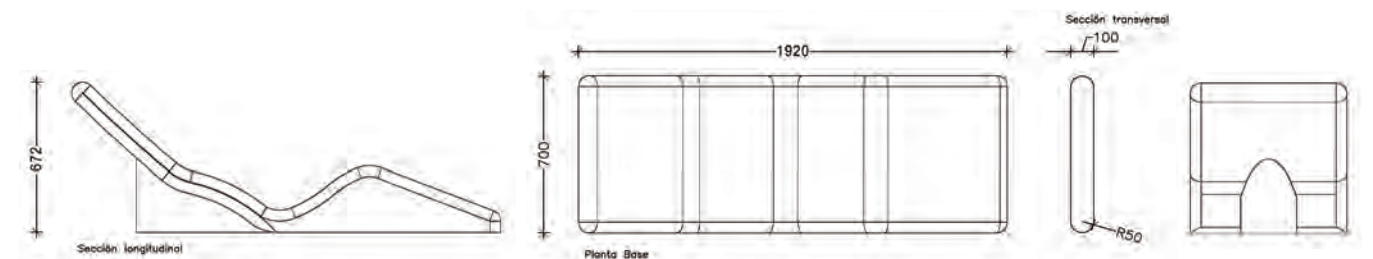

* Lounger supplied without tiles.

ZEN LOUNGER

| | |
|-------|-----------------------------|
| 71963 | ZEN LOUNGER WITHOUT HEATING |
|-------|-----------------------------|

The Lounger Kit Assembly contains:

- Lounger Zen
- Assembly Accessories Kit N.6 (code 72042) included:
 - 1 un. cod. 71626 - Joint Mortar MJ-73 (5 kg),
 - 1 un. cod. CINTA1010 - Adhesive Fiberglass Tape (10 cm x 45 m),
 - 2 un. cod. 71933 - Polymer Adhesive (290 ml)

| | |
|-------|-------------------------------------|
| 71964 | ZEN LOUNGER WITH ELECTRICAL HEATING |
|-------|-------------------------------------|

The Lounger Kit Assembly contains:

- Lounger Zen with heating sheet integrated of 220 W/m².
- Assembly Accessories Kit N.6 (code 72042) included:
 - 1 un. cod. 71626 - Joint Mortar MJ-73 (5 kg),
 - 1 un. cod. CINTA1010 - Adhesive Fiberglass Tape (10 cm x 45 m),
 - 2 un. cod. 71933 - Polymer Adhesive (290 ml)
- 220V to 24V Transformer, to be located in separate room, to wet zone can only pass 24V.

| | |
|------------|--|
| DIMENSIONS | |
|------------|--|

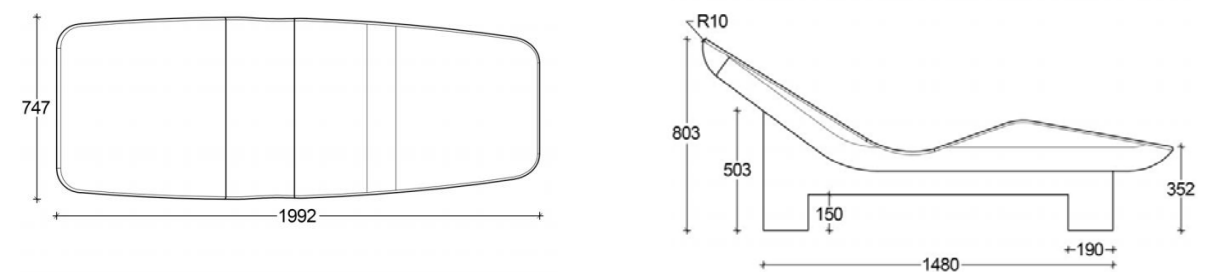

Relax Loungers

RELAX ZONE

SPÆCIAL RELAX LOUNGER

- Completely manufactured in scandinavian spruce.
- Specially designed for humidity areas.
- Not recommended for outdoor use.
- Available in a wide variety of colors.

| | |
|-------|------------------------------------|
| 44421 | SPÆCIAL RELAX LOUNGER |
| 44422 | MATTRESS FOR SPÆCIAL RELAX LOUNGER |

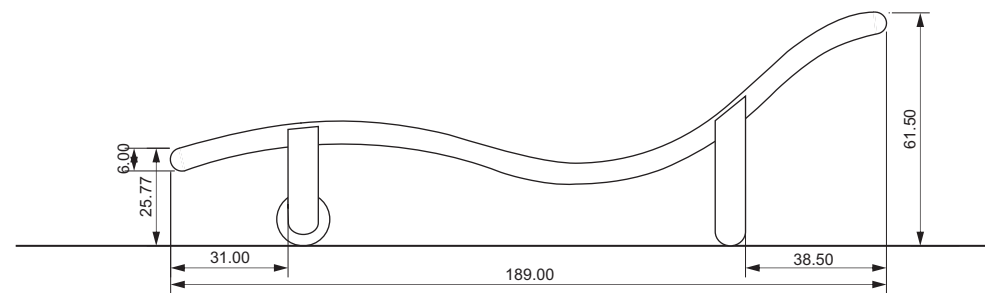

AQUA LOUNGER

| | |
|------------|--------------|
| ON REQUEST | AQUA LOUNGER |
|------------|--------------|

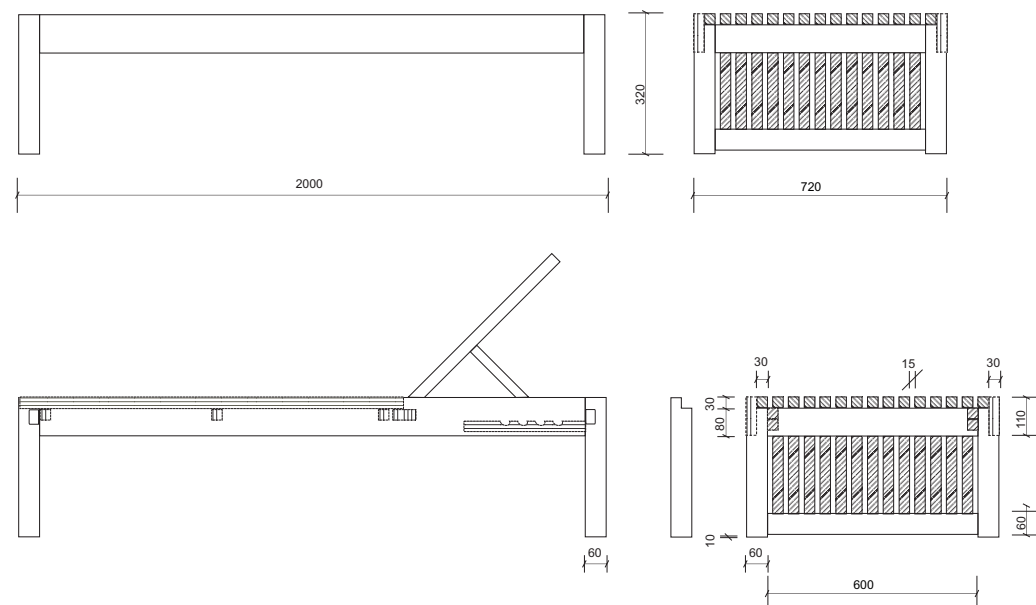

CALM CHAIR

| | |
|-------|--|
| 73901 | CALM - RELAX CHAIR WITH INFRARED LAMPS |
|-------|--|

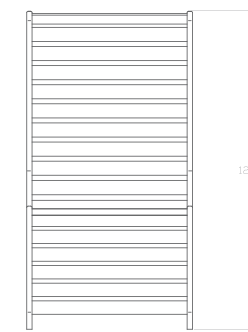
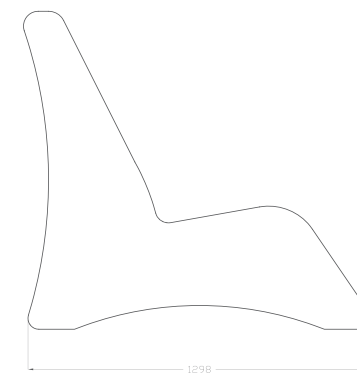
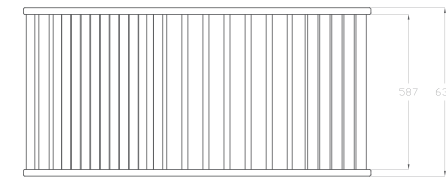

MATERIALS

Sides: Made in birch plywood board with phenolic resin sheets for external protection (depending on the model)
Boards: Made in Iroko.
Levelling feet: AISI 304 stainless steel rod. Plastic support
Neck pad (optional): fireproof Polyskin - M2 category.
Lamp: Lampholder fixed on 3mm HPL structure with 3mm tempered glass protector

CHARACTERISTICS

Dimensions (mm): 1205 x 637 x 1298
Power (kw): 0 / 0,4
Models:
 - Without lamp
 - 4 infrared lamps.

ELECTRIC SYSTEMS

Infrared lamp:
 - Model: PAR 38 IR Red
 - Power: 100 W
 - Useful life: 5000 h
Control pannel: Switch or timing switch
Connection: 230 V I + Neutro

CALM LOUNGER

| | |
|-------|---|
| 73902 | CALM LOUNGE - RELAX DECKCHAIR WITH INFRARED LAMPS |
|-------|---|

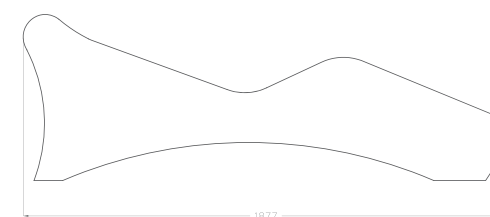
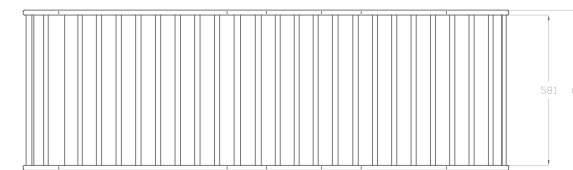

MATERIALS

Sides: Made in birch plywood board with phenolic resin sheets for external protection (depending on the model)
Boards: Made in Iroko.
Levelling feet: AISI 304 stainless steel rod. Plastic support
Neck pad (optional): fireproof Polyskin - M2 category.
Lamp: Lampholder fixed on 3mm HPL structure with 3mm tempered glass protector

CHARACTERISTICS

Dimensions (mm): 683 x 619 x 1877
Power (kw): 0 / 0,4
Models:
 - Without lamp
 - 4 infrared lamps.

ELECTRIC SYSTEMS

Infrared lamp:
 - Model: PAR 38 IR Red
 - Power: 100 W
 - Useful life: 5000 h
Control pannel: Switch or timing switch
Connection: 230 V I + Neutro

Relax Loungers

RELAX ZONE

ELNA LOUNGER

73903 ELNA - RELAX LOUNGER IN SOLID SURFACE

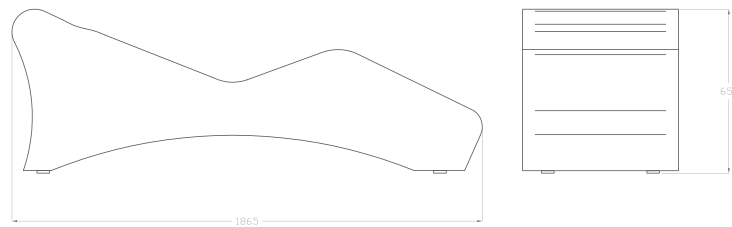

MATERIALS

Lounger: Solid surface of 12 mm thick.

Heating system: Thermal blanket made of 2 layers of 50g/m2 perforated polyester fabric and a PETG protective layer on both sides.

Internal insulation: 10 mm thick construction panel.

Levelling feet: AISI 304 stainless steel rod. Plastic support.

Neck pad: fireproof Polyskin - M2 category.

CHARACTERISTICS

Dimensions (mm): 650 x 560 x 1865

Power (kw): 0,29

ELECTRIC SYSTEMS

Thermal blanket:

– Connection: 24V.

– Power 250 W - 285 W / m2.

Control panel: Digital thermostat with temperature control (max: 40 °C).

Connection: 230 V I + Neutro

VEGA / VEGA WET LOUNGER

N9225 VEGA - RELAX LOUNGER

N9226 VEGA WET - RELAX LOUNGER

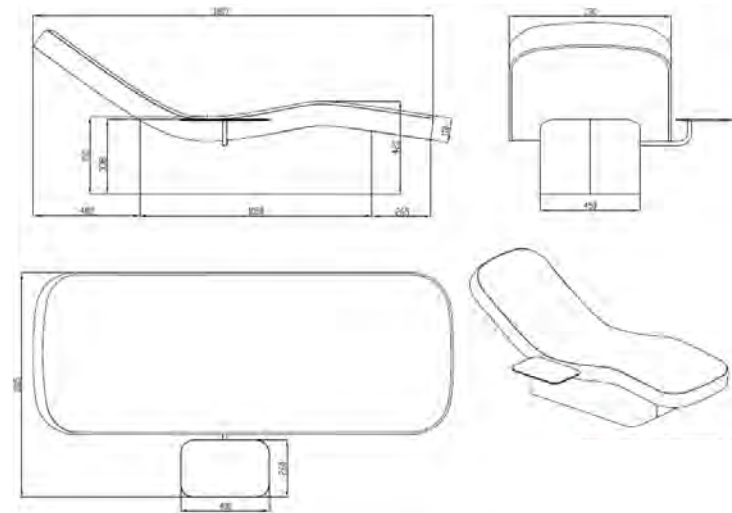

VEGA

– Wooden structure

– Harmonious and ergonomic design and curved shapes

– Fire-resistant "soft-touch" polyurethane upholstery.

VEGA WET

– Metal structure painted in white or other RAL colors (see below)

– Suitable for wet zones

– Harmonious and ergonomic design and curved shapes

– Standard upholstery: "Fire resistant soft-touch" polyurethane.

– Optional upholstery: waterproof (see below)

VEGA / VEGA WET LOUNGER – SKAY STANDARD FINISHES

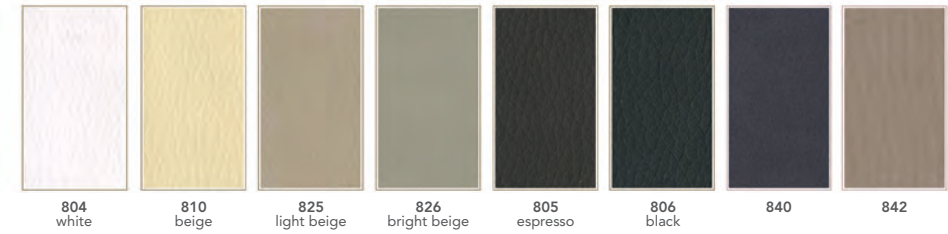

VEGA / VEGA WET LOUNGER – SKAY SPECIAL FINISHES

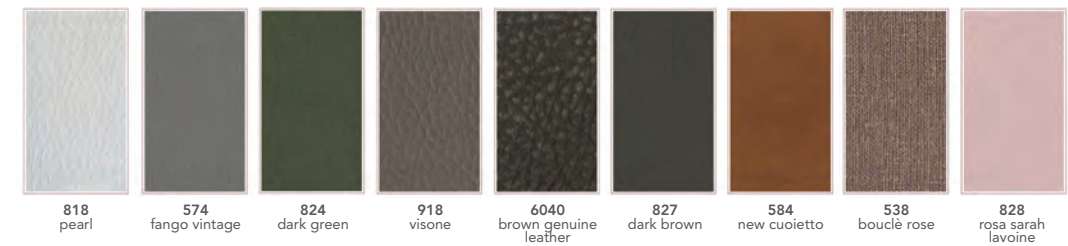

VEGA LOUNGER – STRUCTURE



Wood: Nut

VEGA WET LOUNGER – STRUCTURE



*If the table is placed near a swimming pool or sauna, we recommend the Wet Relax Lounger version (with metal frame and waterproof upholstery)

VEGA WET LOUNGER – OPTIONAL WATER-RESISTANT UPHOLSTERY

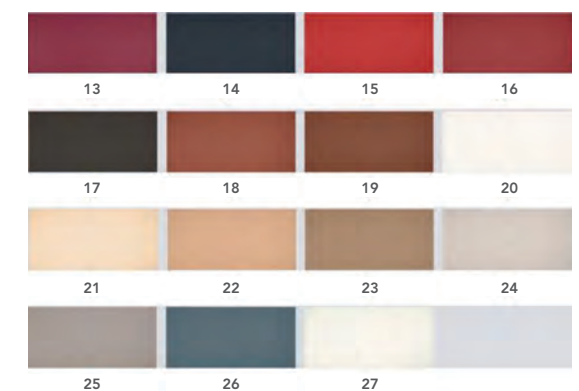
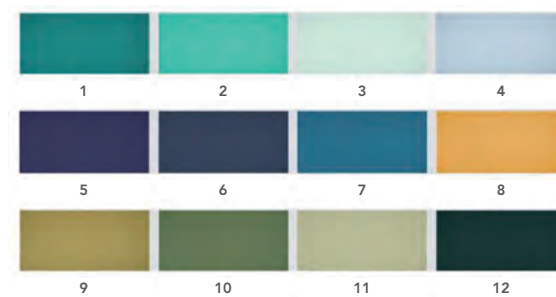

A detailed close-up photograph of a leaf's venation system. The central vein is prominent, with secondary veins branching off at an angle. The leaf surface shows a fine, intricate network of tertiary veins. The lighting is soft, highlighting the texture and color variations of the leaf tissue.

Technical Characteristics

Dafne

TREATMENT ZONE

Treatment Shower

T R E A T M E N T Z O N E

KNEIPP SHOWER

| CODE | DESCRIPTION | CONSUMPTION 3 BAR (L/M) | DIMENSIONS (MM) | MATERIAL | PUSH BUTTON AND TIMER |
|-------|---------------|-------------------------|-----------------|---------------------|-----------------------|
| 73904 | Kneipp Shower | 20 - 30 | 600 x 748 x 172 | Stainless steel 316 | 45219 + 35761 |

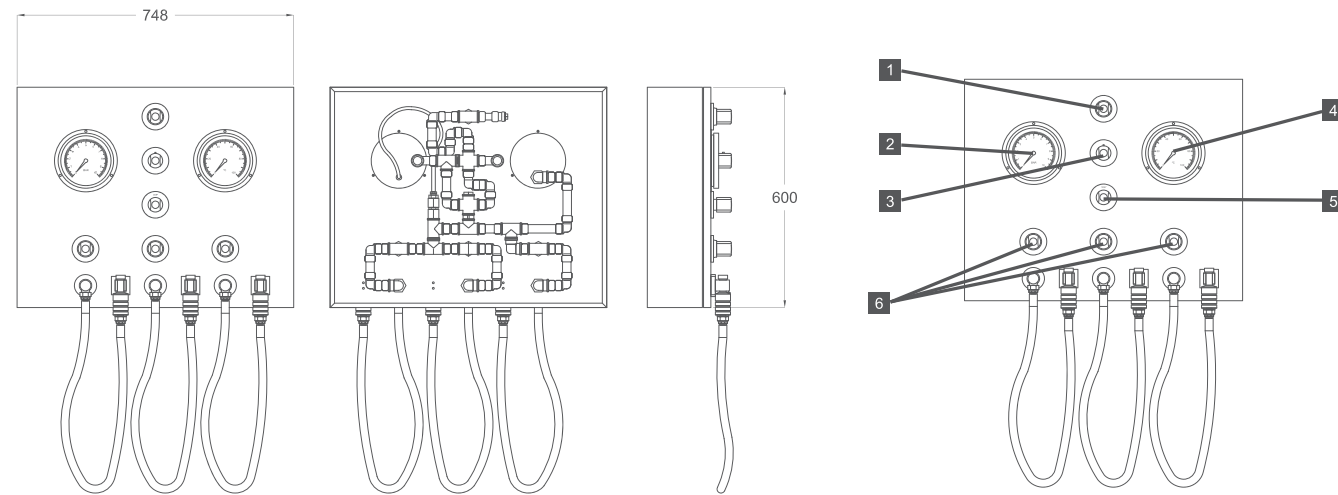

- 1- Shut-off valve for upper sprinkler (Optional)
- 2- Barometer
- 3- Thermostatic mixer
- 4- Thermometer
- 5- Cold/Hot water selector
- 6- Shut-off valve for the different hoses

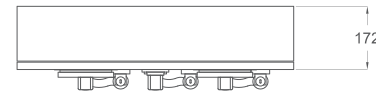

VICHY SHOWER

| CODE | DESCRIPTION | CONSUMPTION 3 BAR (L/M) | POWER (KW) | DIMENSIONS HYDRAULIC EQUIPMENT (MM) | DIMENSIONS ELECTRIC EQUIPMENT (MM) | CONTROL PANNEL | CONNECTION |
|-------|------------------------------|-------------------------|------------|-------------------------------------|------------------------------------|------------------|-----------------------------|
| 73905 | Vichy Shower Articulated arm | 20 - 30 | 0.1 | 420 x 420 x 210 | 290 x 230 x 90 | Touch screen LCD | 230 V + I + Neutro + ground |
| 73906 | Vichy Shower Fixed arm | 20 - 30 | 0.1 | 420 x 420 x 210 | 290 x 230 x 90 | Touch screen LCD | 230 V + I + Neutro + ground |

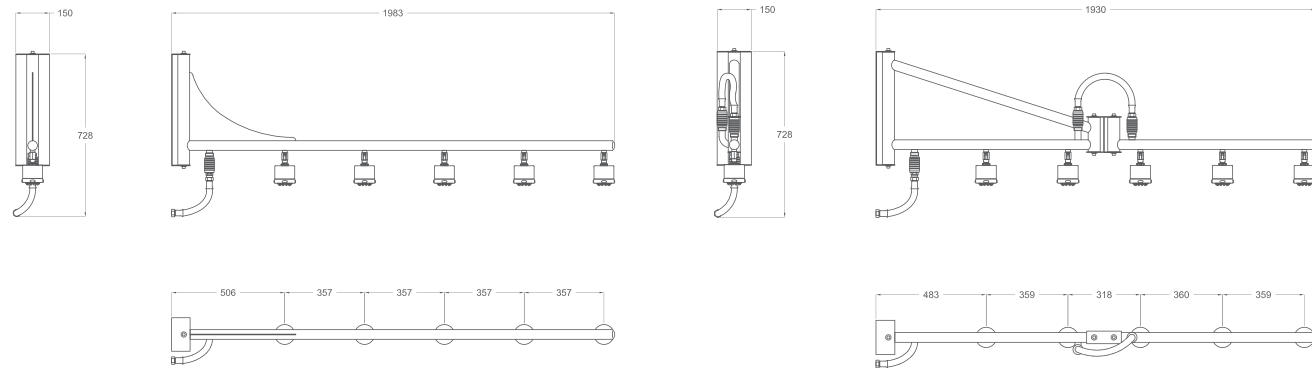

Halotherapy systems

T R E A T M E N T Z O N E

HIMALAYA CUBE

| CODE | DESCRIPTION | SIZE (length x width x height)(cm) | WEIGHT (kg) | POWER (kw) | CONNECTION |
|-------|---------------|------------------------------------|-------------|------------|------------------|
| 73907 | Himalaya Cube | 84 x 64 x 79,4 | 200 | 0,3 | 230 V - 50/60 Hz |

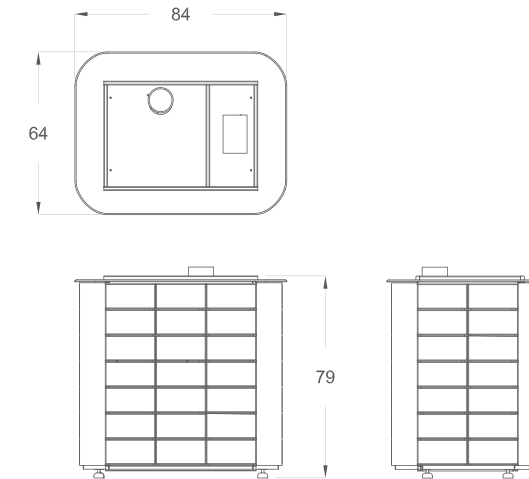

Included elements:

- Pannel control with LED screen.
- Hours schedule programming.
- Aroma diffuser.
- Button for selection.
- Electronic control of temperature.
- Integrated MP3 player with SD electronic card.
- Synchronisation with chromotherapy.
- High power LED chromotherapy.
- Chromotherapy synchronisation with ISO equipment.
- Packaging.

Optionals

- 90118 Air extractor.

SANAMA SALT CABIN

| CODE | MODEL | DIMENSIONS | CABIN PANELS | | | | | | | Bench Wood | OPTIONALS | |
|--------|-------------------|-------------|-----------------|---------------|------------|---------------------------|-----------|----------|--------------|------------|--------------------------------------|-------------|
| | | | Hemlock Plywood | Nordic Spruce | White Pine | Thermo Aspen/Alder / Pine | Red Cedar | Magnolia | Thermo Aspen | | CODE | DESCRIPTION |
| 65400S | Sanama Salt Cabin | 150x150x210 | Standard | N/A | N/A | N/A | N/A | N/A | Thermo Aspen | 70444 | Salt decorative elements set | |
| 65401S | Sanama Salt Cabin | 150x218x210 | | | | | | | | 70447 | External wood trim wall | |
| 65402S | Sanama Salt Cabin | 218x218x210 | | | | | | | | 70457 | RGB chromotherapy remote control kit | |
| 65403S | Sanama Salt Cabin | 286x318x210 | | | | | | | | | | |

SALT WALL

| CODE | DESCRIPTION | SIZE | LIGHTING |
|-------|-------------------|----------------------------|----------------------|
| 73881 | Backlit salt wall | On request /m ² | LED 12 V White strip |

Included elements:

- Mineral salt brick from Asia 200x100x25.
- Transparent laminated glass 5 + 5.
- LED lighting with profile and diffuser.
- 12V power supply.

SALT DIFFUSER

| CODE | DESCRIPTION | CABIN MAXIMUM SIZE (m) | SIZE (mm) | DOSAGE MAXIMUM EFFICIENCY | ELECTRIC CONNECTION | ELECTRIC CONSUM. |
|-------|---|------------------------|----------------|---------------------------------|---------------------|------------------|
| 73882 | Salt nebulizer for inhalation for sauna or dry environment. | 35 | 580 x 630 x 25 | 3.3 l/h in continuous operation | 230v / 50HZ | 400w |

Components:

- Peristaltic pump
- Piston compressor
- Control unit
- Spray nozzle
- Illuminated switch
- Includes a 5L can installed on the structure and a spare 5L can.

Portable massage tables

T R E A T M E N T Z O N E

CONFORTFLEX

| | AFCFLEX3/B | AFCFLEX3/L |
|----------------------------|---|------------|
| Height adjustment: | 26" - 32" (66cm 81cm) | |
| Weight: | 16kgs | |
| Dimensions: | Unfolded: L: 73" (185cm), W: 27" (68cm) | |
| Materials: | Wooden frame with 2.5" Therafoam padding, PU vinyl. | |
| Working weight: | 450lbs (205kgs) impact | |
| Warranty | 2 years | |
| Cradle / Towel support | Both end | |
| Armrest | Included | |
| Headrest | Included | |
| Case | Included | |
| Color | BEIGE | CAFÉLATTE |
| Shipping measures (approx) | L95cm x W23cm x H85cm. Gross weight: 25kg. | |

Features

- Comfortable Therafoam padding
- Soft-touch PU upholstery
- Raisable backrest
- European beech wood frame
- Affinity ergonomic breathing hole and plug
- Easy grip thumbscrews for easy height adjustment
- Reiki panels
- Quick set-up
- Generous height adjustment
- Includes bag with wheels for transport
- Holes on each end to hold the paper towel/ head
- Soft touch carrying handle
- Rounded corners
- Anti-slip feet
- Excellent stability
- Quality construction

DELUXE

| | ADLX2/B | ADLX2/P |
|----------------------------|---|---------|
| Height adjustment: | 26" - 32" (66cm 81cm) | |
| Weight: | 16kgs | |
| Dimensions: | Unfolded: L: 73" (185cm), W: 27" (68cm) Folded: L36.5" (92,7cm), H27" (68cm), D9.4" (24cm) | |
| Materials: | Wooden frame with 2.5" Therafoam padding, PU vinyl. | |
| Working weight: | 450lbs (205kgs) impact | |
| Warranty | 2 years | |
| Cradle / Towel support | Both end | |
| Armrest | Included | |
| Headrest | Included | |
| Case | Included | |
| Color | BEIGE | PURPLE |
| Shipping measures (approx) | L95cm x W26cm x H84cm. Gross weight: 23.5kg. | |

Features

- Comfortable Therafoam padding
- Soft-touch PU upholstery
- Super-comfortable
- European beech wood frame
- Easy grip thumbscrews for easy height adjustment
- Reiki panels
- Quick set-up
- Generous height adjustment
- Includes bag with wheels for transport
- Holes on each end to hold the paper towel/ head
- Soft touch carrying handle
- Rounded corners
- Anti-slip feet
- Excellent stability
- Quality construction

MARLIN

| | ADLX2/B | ADLX2/P |
|----------------------------|---|--------------|
| Height adjustment: | 32.5" (62cm 82.5cm) | |
| Weight: | 25" - 14,4kg | 28" - 16,5kg |
| Dimensions: | Length 73" (185cm), Anchi 25" (63cm)/ Width 28" (71.2cm) | |
| Materials: | Aluminum frame and base with 2" semi firm, padded Therafoam, PVC vinyl " | |
| Working weight: | 450lbs (205kg/32 impact) | |
| Warranty | 2 years | |
| Cradle / Towel support | Both end | |
| Armrest | - | |
| Headrest | - | |
| Case | Included | |
| Color | WHITE | NAVY |
| Shipping measures (approx) | 25" L96cm x W23cm x H70cm. Gross weight: 19kgs. 28" L96cm x W24cm x H78cm. Gross weight: 21kgs | |

Features

- Exceptionally comfortable
- Raisable backrest
- Therafoam Sports Padding
- Easy transport
- Excellent stability
- Clean lines
- Reiki panels
- Quick set-up
- Generous height adjustment
- Affinity ergonomic breathing hole and plug
- The UK's favorite
- Includes bag with wheels for transport
- Holes on each end to hold the paper towel/ head
- Anti-slip feet
- Soft touch carrying handle
- Quality construction
- Solid aluminum frame



Treatment beds

T R E A T M E N T Z O N E

| CODE | DESCRIPTION | MEASURES | NUM. MOTORS | BASE COLOR | OPTIONALS | | |
|---------|-----------------|--------------------|-------------|--|----------------------------|--------------------|---------|
| N8536 | EARTH | 73 x 189 x 75 | - | BICOLOR | Paper clip | Manual Control | |
| N9030 | GENUINE | 76 x 188 x 56/76 | 1 (height) | WHITE | Paper clip | Memory foam option | Thermic |
| N90011 | WELL | 75 x 202 x 64/84 | 3 | WOOD WHITE WENGÈ | Paper clip | | |
| N90011T | WELL THERMIC | 75 x 202 x 64/84 | 3 | | | | |
| N9032 | SENSE | 78,5 x 189 x 54/74 | 4 | | | Memory foam option | |
| N9032T | SENSE THERMIC | 78,5 x 189 x 54/74 | 4 | | | Memory foam option | Armrest |
| N83961 | LAKE | 76 x 202 x 62/82 | 4 | WOOD WHITE WENGÈ | Paper clip | | |
| N8396T | LAKE THERMIC | 76 x 202 x 62/82 | 4 | | | Natural Oak | |
| N9287 | DAPHNE | 82 x 200 x 65/90 | 4 | WHITE OAK OLD WOOD NATURAL OAK WALNUT | | Memory foam option | |
| N9287T | DAPFHNE THERMIC | 82 x 200 x 65/90 | 3 | | | Memory foam option | Thermic |
| N90371 | APOLO | 78,5 x 189 x 62/82 | 4 | WENGÈ NEW GREY | Paper clip | | Thermic |
| N90291 | OCEAN | 74 x 200 x 57/88 | 3 | WOOD WHITE WOOD WHITE | | Memory foam option | |
| N9029T | OCEAN THERMIC | 74 x 200 x 57/88 | 3 | | | | |
| N8951 | NATURA | 81 x 202 x 70 | - | REAL TEAK WOOD | | | |
| N9020 | AQUA | 92 x 219 x 61/81 | 1 | White metal | | | |
| N9022 | VENUS | 92 x 219 x 58/84 | 1 | WOOD WHITE | Traditional mattress in PU | Quartz sand | |
| N9024 | HIMALAYAN | 92 x 219 x 58/84 | 1 | WOOD WHITE | Traditional mattress in PU | | |
| N8355 | AYURVEDIC | 85 x 186 x 68/83 | - | ESPRESSO | | | |

SKAY STANDARD FINISHES

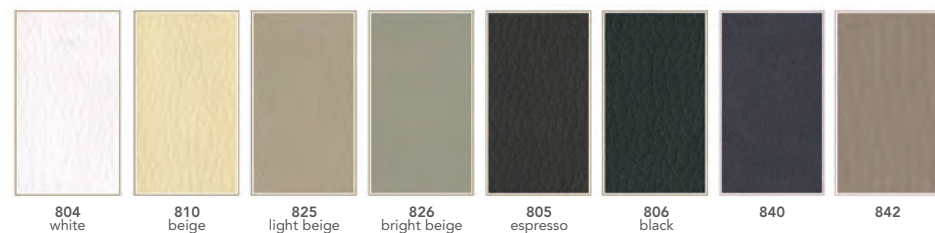

SKAY SPECIAL FINISHES

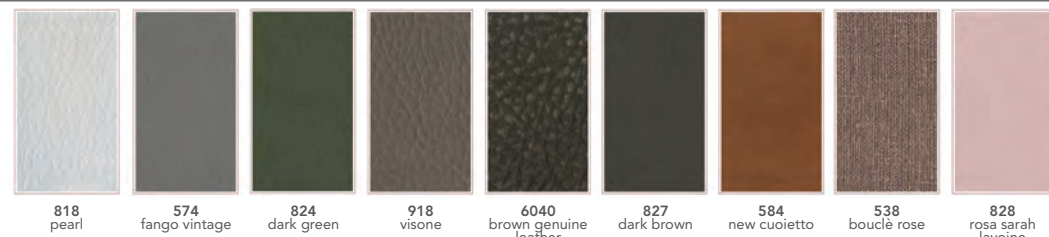

OPTIONAL AYURVEDIC ACCESSORIES

| CODE | DESCRIPTION | |
|--------|---------------------------|--|
| 73764 | AYURVEDA MASSAGE STONE | |
| N91431 | AYURVEDA CUPRUM RAME 2.0 | |
| N8360 | AYURVEDA STEM | |
| N8358 | AYURVEDA ROLL SMALL | |
| N8356 | AYURVEDA SHIRODARA | |
| N8354 | AYURVEDA SMALL OIL WARMER | |
| N5610 | AYURVEDA STONE HEATER | |
| N8361 | AYURVEDA TRAY WTONG | |

FLUIDRA

Avda. Francesc Macià, 60 - Planta 20
08208 Sabadell (Barcelona) - Spain
Tel. : +34 93 724 39 00

www.astralpool.com